

SG13113

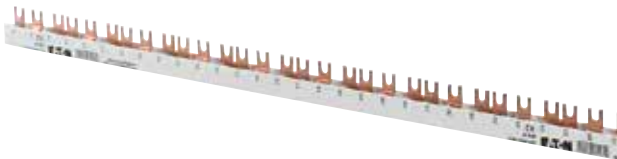

sg03515



wa_sg03511



Wa_sg02902

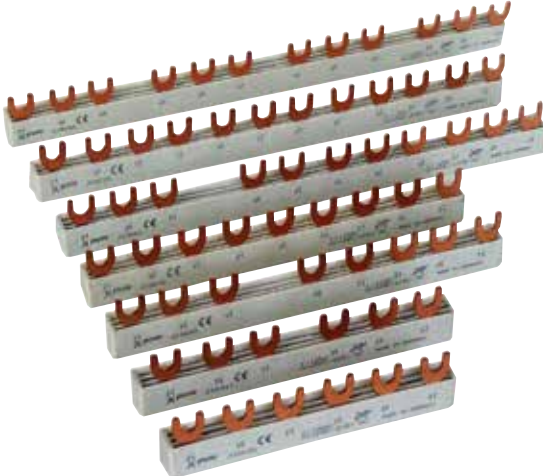

SG13113

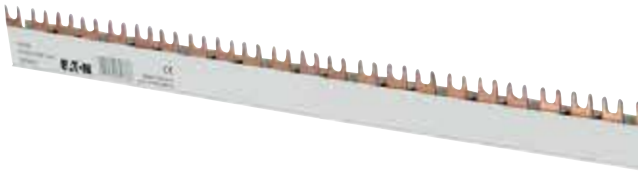

Description

Busbar System xEffect is the modular design system for busbars. xEffect busbars are available as yard goods with 1, 2 or 3 poles. Now, there is a special feature: each bar can easily be extended by one-pole bar as you like. The additional pole can be added completely without tools by easy clamping technique. The lugs or forks in the xEffect bars - available in 10 and 16 mm² and all common distances - can be broken out at a predetermined breaking point. There is actually no more flexibility available.

Busbar System xEffect saves time and material

The yard good can be cut with a saw of course. However, there is no need neither for deburring nor for cutting the conductor. Just cut to the required dimension and close with the fitting end cap -ready! The end caps have also breakable edges, which enable further connecting of the busbar System xEffect. By overlapping assembly, doubling the cross section can be achieved.

Busbar System xEffect in use

Busbar System xEffect is especially well suited for solving flexible busbar applications rack-mounted models in series. Fork-pin combinations for 1+N-applications can be realized by individual combinations - for this also the one-pole version with blue isolation is available besides the one with grey isolation. Even different cross sections can be combined in this case.

Accessories, such as feeder terminals and self adhesive phase marking labels will complete the comfortable total package. Existing contact prevention caps can be used.

Busbar System xEffect at a glance:

- Yard goods can be cut
- No cutting back of copper required
- No deburring required
- Almost no waste during cutting
- End caps available with 1- to 4-poles, end caps can be broken out for further extensions
- 4-pole end cap molded in pairs (left and right)
- Overlapping rail extension possible

- Rails can be extended on demand by 1-pole rails (plug-in technology)
- All step distances
- 10 and 16 mm²
- Fork and stud
- Lugs can be broken out at any predetermined breaking point
- Self adhesive phase indication labels available
- Contact preventing caps (ZV-BS-G) can be used
- Simple, flexible handling
- All assembly requirements can be covered by the busbar System xEffect
- Low storage space requirements due to modular system
- Less time consuming (no deburring, no cutting back)
- Individual and self configurable
- Fork-pin combination for 1+N application possible, feeding through rail (terminal clamp) not possible.
- Protected technology

Description	Step Distance (mm)	Cu-factor	Type Designation	Article No.	Units per package
-------------	--------------------	-----------	------------------	-------------	-------------------

For MCBs, RCCBs, RCBOs, SPDs

- delivered without end caps

SG13113



10 mm², Rated current 63 A

1-phase	17.8	0.22	BB-EVF-10/1P-1MU	168826	10
	27	0.24	BB-EVF-10/1P-1,5MU	168830	10
	36	0.24	BB-EVF-10/1P-2MU	168834	10
2-phases	17.8	0.31	BB-EVF-10/2P-1MU	168838	10
	27	0.36	BB-EVF-10/2P-1,5MU	168840	10
3-phases	17.8	0.46	BB-EVF-10/3P-1MU	168842	10
	27	0.58	BB-EVF-10/3P-1,5MU	168844	10
	36	0.56	BB-EVF-10/3P-2MU	168850	10
3-phases + AUX	3x17.8+1x9	0.58	BB-EVF-10/3P-1MU/AUX	168846	10
	3x17.8+2x9	0.57	BB-EVF-10/3P-1MU/2AUX	168848	10
Neutral	17.8	0.22	BB-EVF-10/N-1MU	168828	10
	27	0.24	BB-EVF-10/N-1,5MU	168832	10
	36	0.24	BB-EVF-10/N-2MU	168836	10

SG13213



16 mm², Rated current 80 A

1-phase	17.8	0.33	BB-EVF-16/1P-1MU	168827	10
	27	0.36	BB-EVF-16/1P-1,5MU	168831	10
	36	0.32	BB-EVF-16/1P-2MU	168835	10
2-phases	17.8	0.46	BB-EVF-16/2P-1MU	168839	10
	27	0.54	BB-EVF-16/2P-1,5MU	168841	10
3-phases	17.8	0.69	BB-EVF-16/3P-1MU	168843	10
	27	0.87	BB-EVF-16/3P-1,5MU	168845	10
	36	0.84	BB-EVF-16/3P-2MU	168851	10
3-phases + AUX	3x17.8+1x9	0.87	BB-EVF-16/3P-1MU/AUX	168847	10
	3x17.8+2x9	0.86	BB-EVF-16/3P-1MU/2AUX	168849	10
Neutral	17.8	0.33	BB-EVF-16/N-1MU	168829	10
	27	0.36	BB-EVF-16/N-1,5MU	168833	10
	36	0.32	BB-EVF-16/N-2MU	168837	10

SG13613



Description	Step Distance (mm)	Cu-factor	Type Designation	Article No.	Units per package
-------------	--------------------	-----------	------------------	-------------	-------------------

For MCBs, RCCBs, RCBOs, SPDs

- delivered without end caps

SG13113



10 mm², Rated current 63 A

1-phase	17.8	0.22	BB-EVP-10/1P-1MU	168852	10
	27	0.24	BB-EVP-10/1P-1,5MU	168856	10
	36	0.24	BB-EVP-10/1P-2MU	168860	10
2-phases	17.8	0.31	BB-EVP-10/2P-1MU	168864	10
	27	0.36	BB-EVP-10/2P-1,5MU	168866	10
3-phases	17.8	0.46	BB-EVP-10/3P-1MU	168868	10
	27	0.58	BB-EVP-10/3P-1,5MU	168870	10
	36	0.56	BB-EVP-10/3P-2MU	168876	10
3-phases + AUX	3x17.8+1x9	0.58	BB-EVP-10/3P-1MU/AUX	168872	10
	3x17.8+2x9	0.57	BB-EVP-10/3P-1MU/2AUX	168874	10
Neutral	17.8	0.22	BB-EVP-10/N-1MU	168854	10
	27	0.24	BB-EVP-10/N-1,5MU	168858	10
	36	0.24	BB-EVP-10/N-2MU	168862	10

SG13413



SG13213



16 mm², Rated current 80 A

1-phase	17.8	0.33	BB-EVP-16/1P-1MU	168853	10
	27	0.36	BB-EVP-16/1P-1,5MU	168857	10
	36	0.32	BB-EVP-16/1P-2MU	168861	10
2-phases	17.8	0.46	BB-EVP-16/2P-1MU	168865	10
	27	0.54	BB-EVP-16/2P-1,5MU	168867	10
3-phases	17.8	0.69	BB-EVP-16/3P-1MU	168869	10
	27	0.87	BB-EVP-16/3P-1,5MU	168871	10
	36	0.84	BB-EVP-16/3P-2MU	168877	10
3-phases + AUX	3x17.8+1x9	0.87	BB-EVP-16/3P-1MU/AUX	168873	10
	3x17.8+2x9	0.86	BB-EVP-16/3P-1MU/2AUX	168875	10
Neutral	17.8	0.33	BB-EVP-16/N-1MU	168855	10
	27	0.36	BB-EVP-16/N-1,5MU	168859	10
	36	0.32	BB-EVP-16/N-2 MU	168863	10

SG13613



Accessories

End Caps BB-EV-EC

wa_sg05612



1-phase	-	-	BB-EV-EC/1P	168878	40
2+3-phases	-	-	BB-EV-EC/2-3P	168823	40
4-phases	-	-	BB-EV-EC/4P	168824	20
Neutral	-	-	BB-EV-EC/N	168879	20

Terminal BB-EV-MU/35

wa_sg05312



-	-	0.04	BB-EV-MU/35	168825	3
---	---	------	-------------	--------	---

Sticker Phase Sequence

SG08713



-	-	-	BB-S-PS	169831	5
---	---	---	---------	--------	---

Busbar Tag Shrouds ZV-BS-G

SG05706



-	-	-	ZV-BS-G	104903	10/600
---	---	---	---------	--------	--------

Technical Data

		BB-EV.
General		
Heat deflection temperature		≥ 80°C UL94 V0
Standards		EN 60947-1:2007 / IEC 60947-1:2007 / IEC 60999:2000
Climate stability		according to DIN EN 60068
Insulation coordination		Overvoltage category III / Pollution degree 2
Electrical		
Impulse voltage strenght		≥ 4.5 kV
Min. air distance		>5.5 mm
Min. creeping distance		>5 mm
Max. operating voltage		690 V AC/DC 1,000 V DC 1-pole only
Max. busbar current	I _s /Phase	
10 mm ²		63 A
16 mm ²		80 A
Protection class		IP20
Short circuit rating	I _{cc}	25 kA - NH3 355A, gC500V JM
Dielectric strenght		PC - ABS >32 kV / mm

Assembly instruction:

Cutting

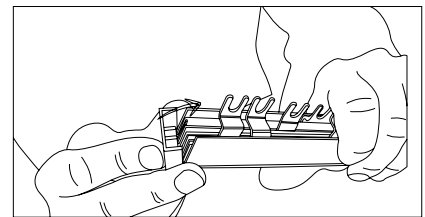
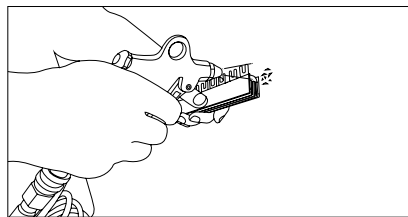
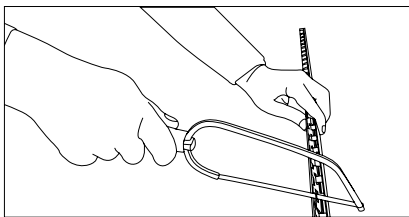

Mounting of an extension busbar

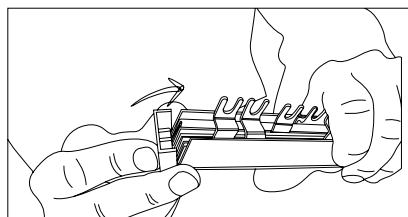
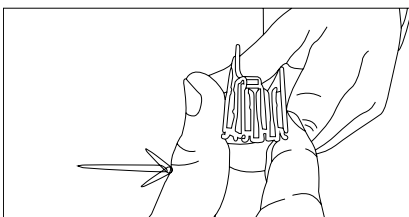
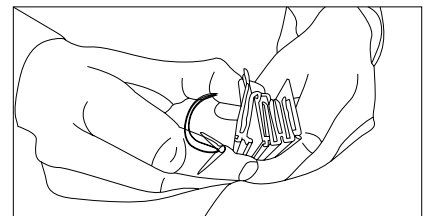
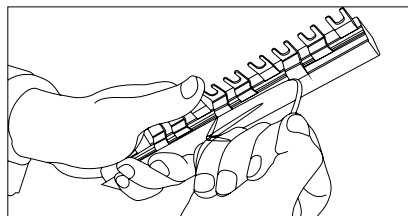
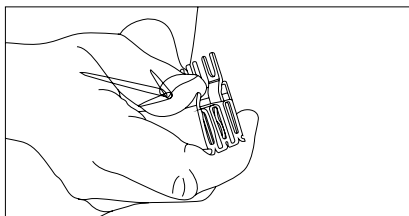

Overlapping mounting or further connection, resp.

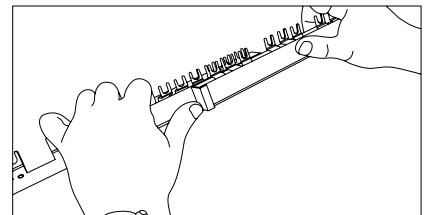
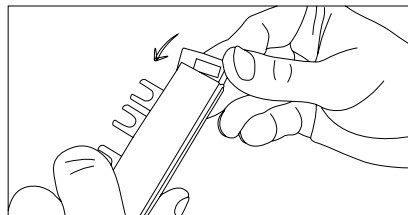
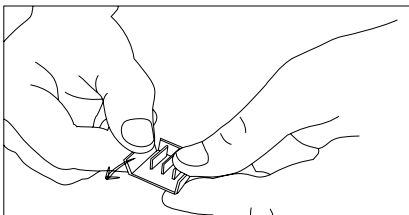

Breacking out of connection lugs

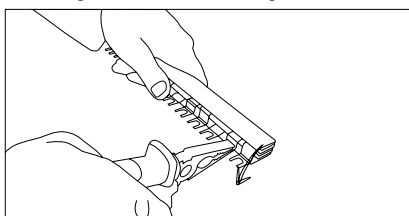

Sticking on phase marking

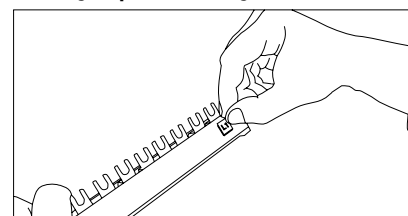

Plug-in busbar System 50 A, 80 A ZV

for PLS., PKN., PFIM, PFHM (with Auxiliary Switch)

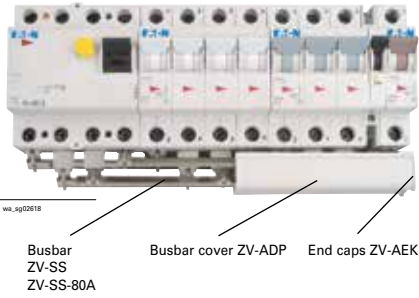

Description	Cu-factor	Type Designation	Article No.	Units per package
-------------	-----------	------------------	-------------	-------------------

Connection Angle L1, N



Same connection angle ZV-L1/N (-80A), for L1 and N, turned by 180°

50 A				
10 units	0.005	ZV-L1/N-10	263941	10 / 600
36 units	0.005	ZV-L1/N-36	263942	36 / 2160
100 units	0.005	ZV-L1/N-100	263943	100 / 3000
80 A				
10 units	0.005	ZV-L1/N-80A-10	263950	10 / 600
36 units	0.005	ZV-L1/N-80A-36	263951	36 / 2160
100 units	0.005	ZV-L1/N-80A-100	263952	100 / 3000

Connection Angle L2, L3



Same connection angle ZV-L2/L3(-80A), for L2 and L3, turned by 180°

50 A				
10 units	0.007	ZV-L2/L3-10	263944	10 / 600
36 units	0.007	ZV-L2/L3-36	263945	36 / 2160
100 units	0.007	ZV-L2/L3-100	263946	100 / 3000
80 A				
10 units	0.007	ZV-L2/L3-80A-10	263953	10 / 600
36 units	0.007	ZV-L2/L3-80A-36	263954	36 / 2160
100 units	0.007	ZV-L2/L3-80A-100	263955	100 / 3000

Connection Angle N (0.5 MU) for PLSM

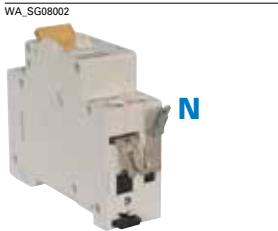

Same connection angle ZV-N-05TE for N 50 and 80 A busbar

50 A				
10 units	0.005	ZV-N-05TE-10	263947	10 / 600
36 units	0.005	ZV-N-05TE-36	263948	36 / 2160
80 A				
100 units	0.005	ZV-N-05TE-100	263949	100 / 3000

Busbar 1m

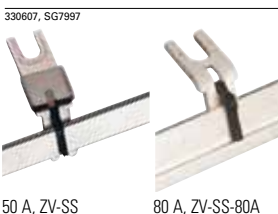

50 A, ZV-SS

80 A, ZV-SS-80A

50 A				
	0.143	ZV-SS	263956	1 / 10
80 A				
	0.230	ZV-SS-80A	263957	1 / 10

Description	Type Designation	Article No.	Units per package
Accessories			
Busbar cover 1m, for 50+80 A	ZV-ADP	263958	1 / 10
End caps for busbar cover	ZV-AEK	263959	10 / 600
Power feed block 35/50mm ²	Z-D80	248269	12 / 120

Description Plug-in busbar System 50 A, 80 A ZV

- Any combinations of switchgear with or without auxiliary switch possible
- Low number of components, 2 angle types per busbar cross-section for three-phases AC
- Same busbar cover and end caps for ZV-SS and ZV-SS-80A
- Short-circuit withstand strength and dielectric properties tested according to IEC/EN 60439-1

Technical Data

		ZV
Electrical		
Rated operational voltage		240/415 VA C
Rated frequency		50/60 Hz, DC
Rated voltage		690 V (at Pollution degree 2) 440 V (at Pollution degree 3)
Overvoltage category		III
Rated peak withstand voltage	U_{imp}	4 kV
Rated current		
ZV-./., ZV-SS		50 A
ZV-./.-80A, ZV-SS-80A		80 A
ZV.-N-05TE		32 A
Conditional rated short circuit current		
AC with 125 A gG		
ZV-./., ZV-SS		50 kA
ZV-./.-80A, ZV-SS-80A		50 kA
ZV.-N-05TE		10 kA
AC with 160 A gG		
ZV-./., ZV-SS		–
ZV-./.-80A, ZV-SS-80A		50 kA
ZV.-N-05TE		10 kA
DC with 160 A gG		
ZV-./., ZV-SS		10 kA
ZV-./.-80A, ZV-SS-80A		10 kA
ZV.-N-05TE		–
Mechanical		
Busbar cross section		
ZV-SS		16 mm ² Cu
ZV-SS-80A		25 mm ² Cu
Busbar length		1 m
Degree of protection mounted with busbar cover and end caps		IP20
Pollution degree		2 (3)
Air gap		≥ 3.2 mm
Minimum creepage distance		≥ 7 mm

Connection diagram

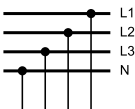

Dimensions (mm) 50 A

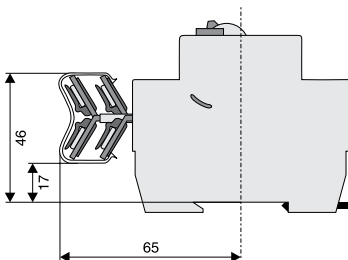

Dimensions (mm) 80 A

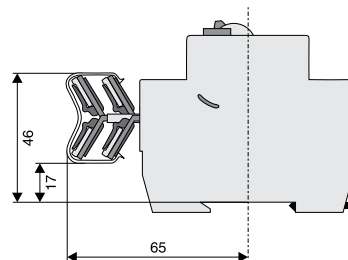

Description	Cu-factor	Type Designation	Article No.	Units per package
-------------	-----------	------------------	-------------	-------------------

Busbar Block (Fork) Z-GV

- for PXL, PXX, PXF, PLS., PKN., PFIM, PFHM, Z-SLS/D01

Busbar Block (Fork) Z-GV

- delivered with end caps

sg03615



16 mm² - Rated current 80 A

1-phase 16x	0.095	Z-GV-16/1P-1MU/16	271074	50
2-phases 8x	0.187	Z-GV-16/1P+N-2MU/16	271075	20
4-phases 4x	0.444	Z-GV-16/3P+N-4MU/16	271078	15

Busbar Block (Fork) Z-GV, 1 Meter

- delivered without end caps

sg03615

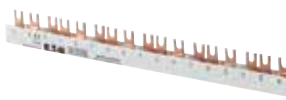

10 mm² - Rated current 63 A

1-phase	0.408	Z-GV-10/1P-1MU	270339	50
3-phases	0.739	Z-GV-10/3P-3MU	271060	20
3-phases	0.739	Z-GV-10/3P-4MU	271080	20
End cap 1-phase		Z-V-AK/1P	104905	10 / 600
End cap 2+3-phases		BB-EC/2+3P	120805	10 / 600

16 mm² - Rated current 80 A

1-phase	0.470	Z-GV-16/1P-1MU	271061	50
1-phase + Auxiliary Switch	0.470	Z-GV-16/1P+HS	271062	50
2-phases	0.657	Z-GV-16/1P+N-2MU	271063	20
3-phases	1.042	Z-GV-16/3P-3MU	271064	20
3-phases + Auxiliary Switch	0.998	Z-GV-16/3P+HS	271065	20
4-phases	1.465	Z-GV-16/3P+N-4MU	271066	15
4-phases	1.522	Z-GV-16/3P+3N-6MU	263142	15
4-phases	1.050	Z-GV-16/PKPX/4PHAS	116882	10
End cap 1-phase		Z-V-AK/1P	104905	10 / 600
End cap 2+3-phases		BB-EC/2+3P	120805	10 / 600
End cap 4-phases		Z-V-AK/4P	264931	10 / 600

Description	Type Designation	Article No.	Units per package
-------------	------------------	-------------	-------------------

Accessories

Busbar Tag Shrouds for busbar, yellow ZV-BS-G

SG05705



Finger and hand touch safe	ZV-BS-G	104903	10 / 600
----------------------------	---------	--------	----------

Description of the Busbar Block (Fork) Z-GV

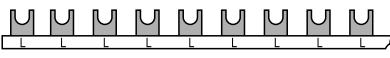
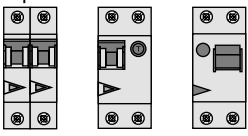
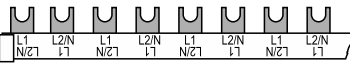
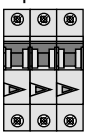
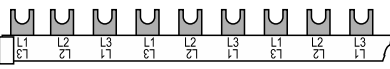
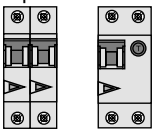
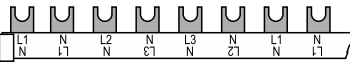
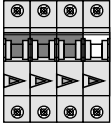
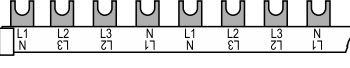
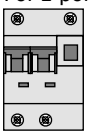
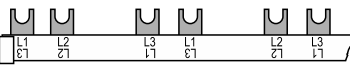
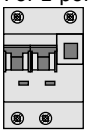
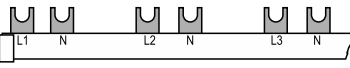
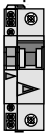
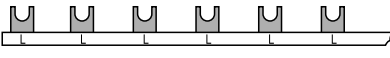
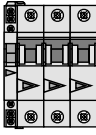
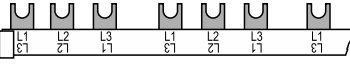
Devices to busbar	Pcs. of the devices	End caps	Type
<p>1-phase</p> 	<p>x57 x57 x16</p>	<p>Z-V- AK/1P</p> 	<p>Z-GV-10/1P-1TE Z-GV-16/1P-1TE Z-GV-16/1P-1TE/16</p>
<p>2-phases</p> 	<p>x28 x8</p>	<p>Z-AK- 16/2+3P</p> 	<p>Z-GV-16/1P+N-2TE Z-GV-16/1P+N-2TE/16</p>
<p>3-phases</p> 	<p>x19 x19 x2 x5</p>	<p>Z-AK- 10/2+3P Z-AK- 16/2+3P</p> 	<p>Z-GV-10/3P-3TE Z-GV-16/3P-3TE Z-GV-16/3P-3TE/8 Z-GV-16/3P-3TE/16</p>
<p>4-phases</p> 	<p>x27</p>	<p>Z-AK- 16/4P</p> 	<p>Z-GV-16/3P+3N-6TE</p>
	<p>x14 x4</p>	<p>Z-AK- 16/4P</p> 	<p>Z-GV-16/3P+N-4TE Z-GV-16/3P+N-4TE/16</p>
<p>For 2-pole Combined RCD/MCB Device, 3-phases</p> 	<p>x18 x6</p>	<p>Z-AK- 10/2+3P</p> 	<p>Z-GV-10/3P-4TE Z-GV-10/3P-4TE/17</p>
<p>For 2-pole Combined RCD/MCB Device, 4-phases</p> 	<p>x18</p>	<p>Z-V-AK/ 4P</p> 	<p>Z-GV-16/PKPX/4PHAS</p>
<p>1-phase + Auxiliary Switch</p> 	<p>x38</p>	<p>Z-V- AK/1P</p> 	<p>Z-GV-16/1P+HS</p>
<p>3-phases + Auxiliary Switch</p> 	<p>x16</p>	<p>Z-AK- 16/2+3P</p> 	<p>Z-GV-16/3P+HS</p>

Description Busbar Block 10mm², 16mm² (Fork) Z-GV

- Length 1m
- Delivered without end caps. Please order separately.
- Short version (/17, /16, /8) delivered with end caps

Technical Data

	Z-GV
Electrical	
Rated voltage	240/415 V, 50/60 Hz
Rated current	
10 mm ²	63 A
16 mm ²	80 A
Short-circuit current strength	25 kA
Mechanical	
Busbar cross section	10 and 16 mm ² Cu
Step distance	17.8 mm
Z-GV-16-P+HS	17.8/27 mm

Connection diagram

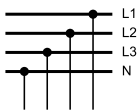

Dimensions (mm)

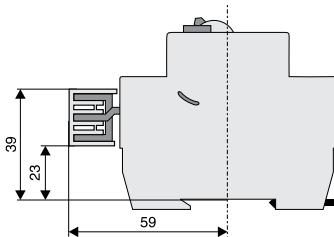

1.102 Busbar Systems

Busbar Block (Fork) GVK

xPole

WA_REN_SG_01922_L, WA_REN_SG_01322_R, WA_REN_SG_01522_C

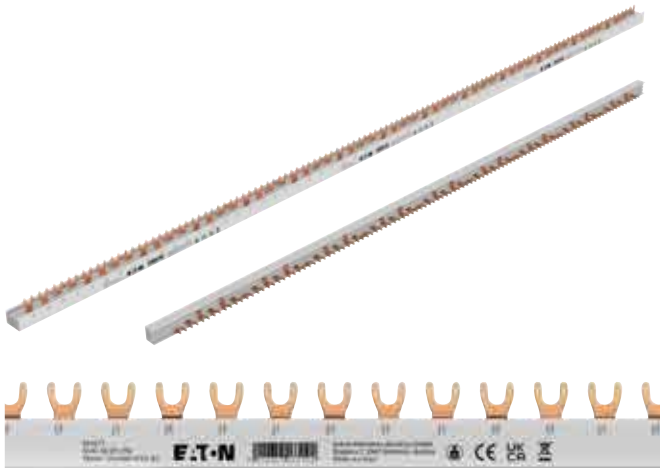

Description

- Available in 10 and 16 mm² cross section
- Fork type
- 3- to 4-phases end caps available as accessories
- End caps must be ordered separately
- Comes in 1 meter length
- Busbar can be cut to desired length

Description	Cu-factor	Type Designation	Article No.	Units per package
-------------	-----------	------------------	-------------	-------------------

Busbar Block (Fork) GVK

- delivered without end caps
- comes in 1 meter length
- can be cut to length

10 mm² - Rated current 63 A

WA_REN_SG_01922_L



3-phases	0.350	GVK-10/3P-3TE	501073	20
----------	-------	---------------	--------	----

16 mm² - Rated current 80 A

3-phases	0.523	GVK-16/3P-3TE	501071	20
4-phases	0.660	GVK-16/3P+N-4TE	501074	15
4-phases	0.610	GVK-16/3P+3N-6TE	501072	15

Accessories

Description	Type Designation	Article No.	Units per package
-------------	------------------	-------------	-------------------

WA_REN_SG_00822_L



End cap 3-Phases for 10 mm ²	EK-3/10-EVGK-GVK	501076	10 / 5000
End cap 3-Phases for 16 mm ²	EK-3/16-EVGK-GVK	501077	10 / 5000
End cap 4-Phases for 16 mm ²	EK-3N/16-EVGK-GVK	501078	10 / 5000

Description	Type Designation	Article No.	Units per package
-------------	------------------	-------------	-------------------

Accessories

Busbar Tag Shrouds for busbar, yellow ZV-BS-G

SG05705



Finger and hand touch safe	ZV-BS-G	104903	10 / 600
----------------------------	---------	--------	----------

Description Busbar Block 10mm², 16mm² (Fork) GVK

- GVK busbars can be cut to length
- Endcaps are not included and should be ordered separately

Technical Data

GVK	
General	
Standards	DIN EN 61439-1:2021-10 / DIN EN 61439-6:2013-06 IEC 664 / IEC 60895-2-12 / VDE 0110 / DIN EN 60754-1
Climate stability	according to IEC 68-2
Overvoltage category	III
Pollution Degree	2
Busbar Material	E-Cu-ETP
Isolation Material	PC-ABS
Endcap Material	PC-ABS
Touch protection Material	PP
Electrical	
Rated operating voltage	400 V AC
Rated current	
10 mm ²	63 A
16 mm ²	80 A
Short-circuit current strength	25 kA /100 A gl
Disruptive Strength	36 kV/mm
Surge Voltage	U_{imp} 4 kV
Mechanical	
Busbar cross section	10 and 16 mm ²
Step distance	17.8 mm

Feeding

Side Feeding

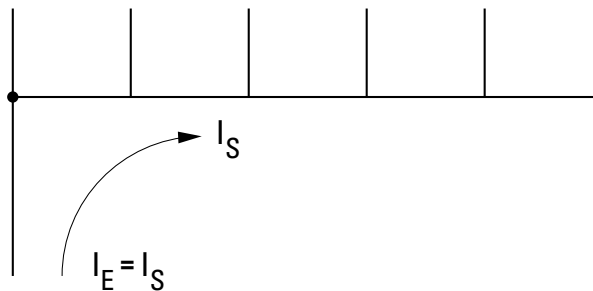

Central Feeding

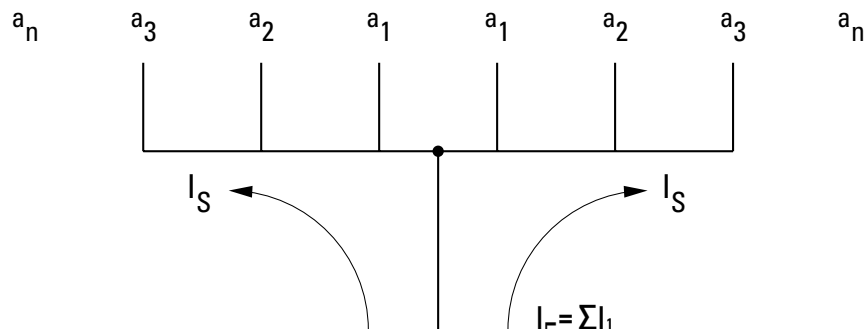

Using central supply feeding you must be sure that the sum of the output current depending on $a_1 \dots a_n$ of each busbar part is not greater than the above max. busbar current I_s / phase

Connection diagram

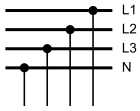

Description Graphics

Devices to busbar	Pcs. of the devices	End caps		Type
<p>3-phases</p>	<p>x19</p> <p>x19</p>	<p>EK-3/10-EVGK-GVK</p> <p>EK-3/16-EVGK-GVK</p>		<p>GVK-10/3P-3TE</p> <p>GVK-16/3P-3TE</p>
<p>2-phases (3P + 3N)</p>	<p>x27</p>	<p>EK-3N/16-EVGK-GVK</p>		<p>GVK-16/3P+3N-6TE</p>
<p>4-phases</p>	<p>x14</p>	<p>EK-3N/16-EVGK-GVK</p>		<p>GVK-16/3P+N-4TE</p>

Dimensions (mm)

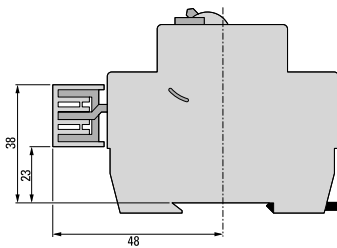

End Cap dimensions (mm)

EK-3/10-EVGK-GVK

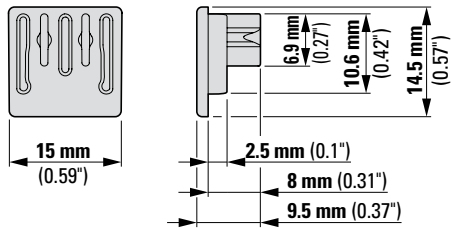

EK-3/16-EVGK-GVK

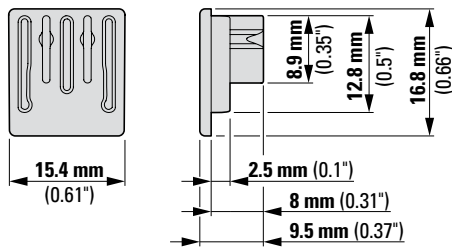

EK-3N/16-EVGK-GVK

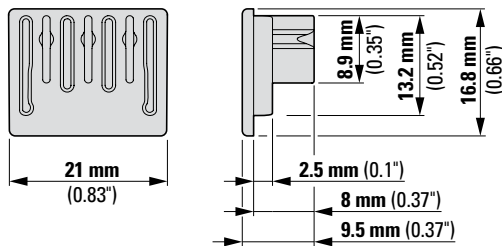

Busbar dimensions (mm)

GVK-10/3P-3TE

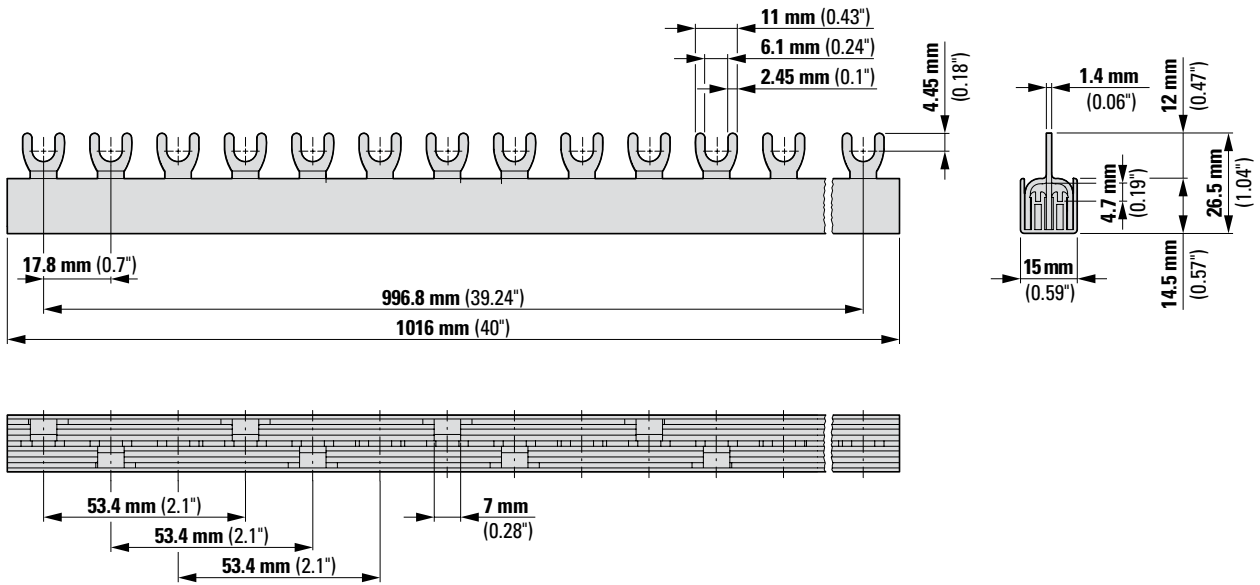

GVK-16/3P-3TE

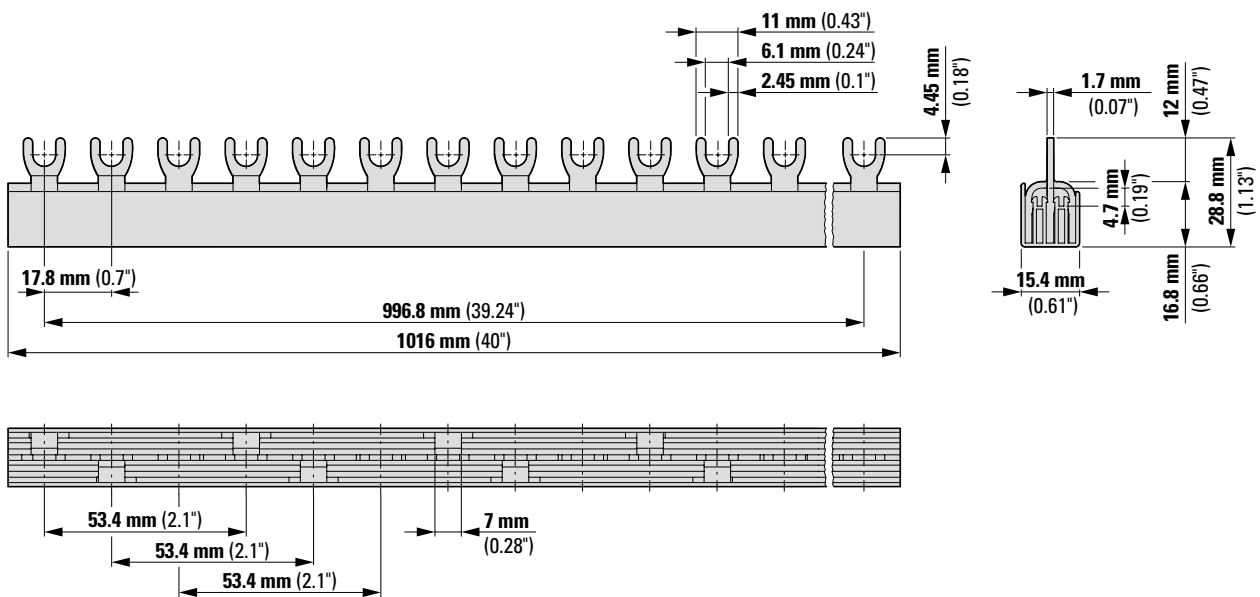

Busbar dimensions (mm)

GVK-16/3P+N-4TE

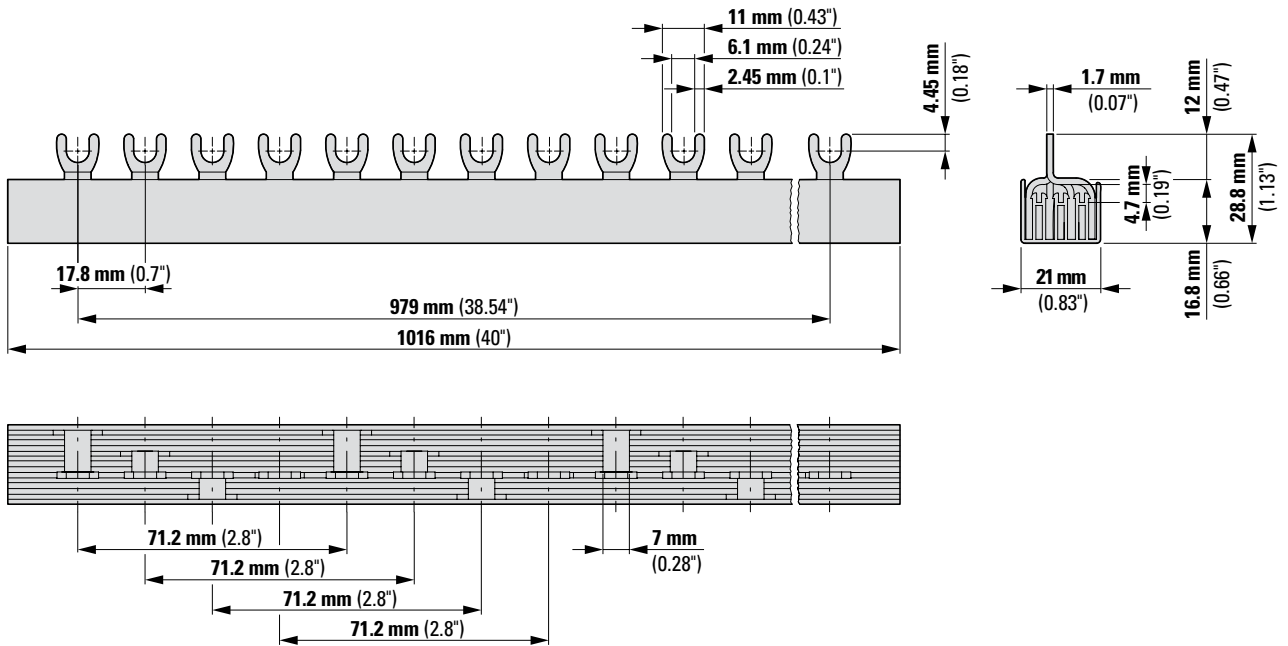

GVK-16/3P+3N-6TE

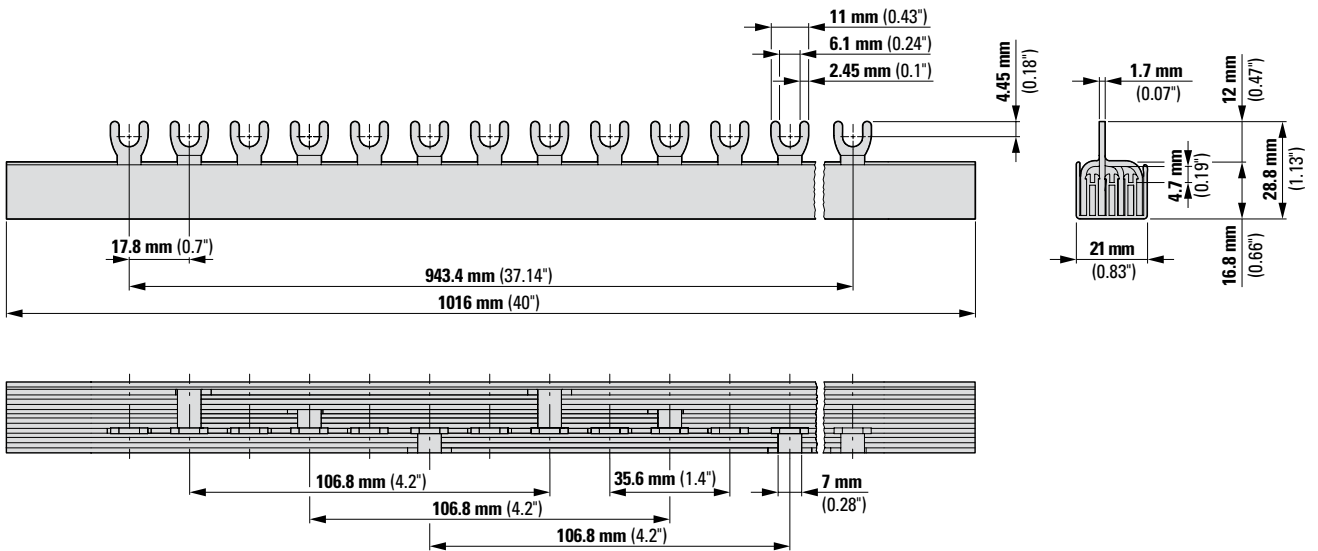

WA_SG11302

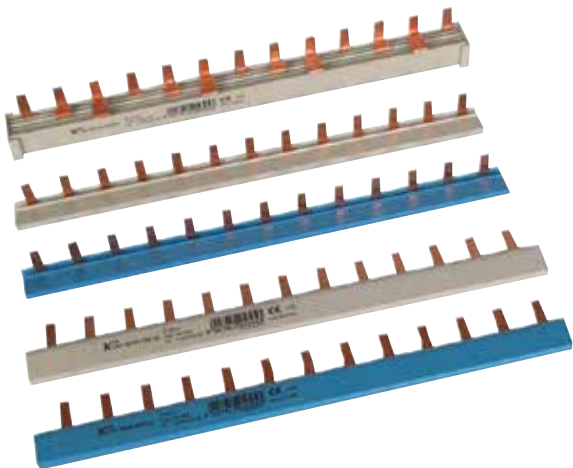

WA_SG11302

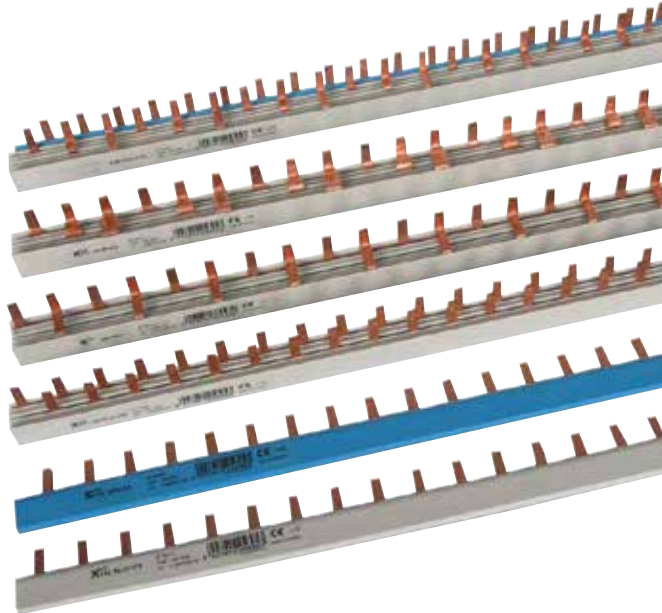

Description	Cu-factor	Type Designation	Article No.	Units per package
-------------	-----------	------------------	-------------	-------------------

Busbar Block (Fork and Pin) Z-GSV

- for PLS.1N (1.5MU)

Busbar Block (Fork and Pin) Z-GSV

- delivered with end caps



10 mm² - Rated current 63 A

4-phases	0.208	Z-GSV-10/FI+EH+2XLS1N	113138	10
4-phases	0.277	Z-GSV-10/FI+EH+4XLS1N	113139	10

16 mm² - Rated current 80 A

4-phases 3x	0.408	Z-GSV-16/3P+3N/9	271079	15
-------------	-------	------------------	--------	----

Busbar Block (Fork and Pin) Z-GSV, 1 Meter

- delivered without end caps



16 mm² - Rated current 80 A

2-phases	0.585	Z-GSV-16/1P+N	271067	10
4-phases	1.840	Z-GSV-16/3P+3N	271068	10
4-phases	2.196	Z-GSV-16/FI+EH+KR+30XLS1N	113137	7
End cap 4-phases		Z-V-AK/4P	264931	10 / 600

Description of the Busbar Block (Fork and Pin) Z-GSV

Devices to busbar	Pcs. of the devices	End caps	Type
<p>4-phases</p>		Z-V-AK/4P	Z-GSV-10/FI+EH+2XLS1N
<p>4-phases</p>		Z-V-AK/4P	Z-GSV-10/FI+EH+4XLS1N
<p>2-phases</p>	x37 x9	Z-AK-16/2+3P	Z-GSV-16/1P+N Z-GSV-16/1P+N/9
<p>4-phases</p>	x37 x9	Z-AK-16/4P	Z-GSV-16/3P+3N Z-GSV-16/3P+3N/9
<p>4-phases</p>		Z-V-AK/4P	Z-GSV-16/FI+EH+KR+30XLS1N

Description Busbar Block 10mm², 16mm² (Fork and Pin) Z-GSV

- Length 1m
- Delivered without end caps. Please order separately.
- Short version (/9) delivered with end caps

Technical Data

	Z-GSV
Electrical	
Rated voltage	240/415 V, 50/60 Hz
Rated current	
10 mm ²	63 A
16 mm ²	80 A
Short-circuit current strength	25 kA
Mechanical	
Busbar cross section	10 and 16 mm ² Cu
Step distance	26.7 mm

Connection diagram

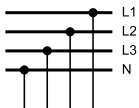

Dimensions (mm)

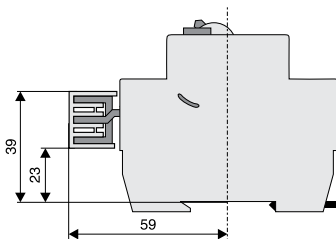

1.112 Busbar Systems

xPole

Busbar Block (Pin) Z-SV...-SD, 1 Meter

Description	Cu-factor	Type Designation	Article No.	Units per package
-------------	-----------	------------------	-------------	-------------------

Busbar Block (Pin) Z-SV...-SD, 1 Meter

- For Protected Earth Socket Z-SD230
- delivered with end caps

10 mm² - Rated current 50 A

Z-phases	0.588	Z-SV-10/1P+N-SD	269526	10
End caps		Z-V-AK/2+3P	264930	10 / 600

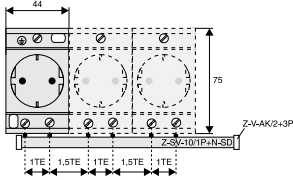

Description Busbar Block 10mm² (Pin) Z-SV ...-SD

- Delivered without end caps
- Step (distance between two pins of identical phase, i. e. L or N) 2.5 MU
- Length 1 m

Technical Data

	Z-SV-10/1P+N-SD
Electrical	
Rated voltage	230/400 V, 50/60 Hz
Rated current	50 A
Short-circuit current strength	25 kA
Mechanical	
Busbar cross section	10 mm ² Cu
Step distance	44 mm

Connection diagram

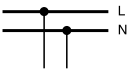

Accessories

WA_SG10602



End caps

WA_SG10702



Extension terminal
Z-EK/25/QL

WA_SG10702



Extension terminal
Z-EK/25

Description	Cu-factor	Type Designation	Article No.	Units per package
-------------	-----------	------------------	-------------	-------------------

Busbar Block (Pin) Z-SV

- for PLN. (1MU), Z-SI

Busbar Block (Pin) Z-SV, 13TE

- delivered with end caps

WA_SG11302

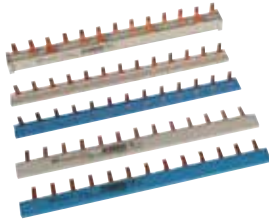

10 mm² - Rated current 50 A

1-phase straight grey	0.055	Z-SV-10/1P-1MU/13	264916	10
1-phase straight blue	0.055	Z-SV-10/N-1MU/13	264917	10
1-phase angled grey	0.055	Z-SV-10/1P-F/13	264918	10
1-phase angled blue	0.055	Z-SV-10/N-F/13	264919	10
2-phases	0.126	Z-SV-10/2P-2MU/13	264922	10
3-phases	0.203	Z-SV-10/3P-3TE/13	264924	10
4-phases	0.258	Z-SV-10/3P+N-4TE/12	264926	10
4-phases (for PLN.)	0.258	Z-SV-10/3P+3N-3TE/13	264927	10

Busbar Block (Pin) Z-SV, 1 Meter

- delivered without end caps

WA_SG11302

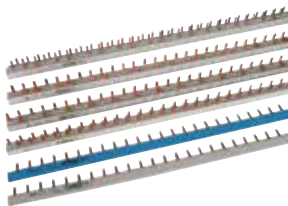

16 mm² - Rated current 63 A

1-phase straight grey	0.385	Z-SV-16/1P-1MU	264912	25
1-phase straight blue	0.385	Z-SV-16/N-1MU	264913	25
1-phase angled grey	0.385	Z-SV-16/1P-1MU/F	269523	25
1-phase angled blue	0.385	Z-SV-16/N-1MU/F	269524	25
2-phases	0.941	Z-SV-16/2P-2MU	264923	10
3-phases (for PLN.)	1.326	Z-SV-16/2P+2N-2MU	264914	7
3-phases	1.422	Z-SV-16/3P-3TE	264925	10
4-phases	2.177	Z-SV-16/3P+N-4TE	264928	7
4-phases (for PLN.)	1.807	Z-SV-16/3P+3N-3TE	264915	7

Description	Type Designation	Article No.	Units per package
-------------	------------------	-------------	-------------------

Accessories

End caps, Z-V-AK/, Z-BB-EC/4P

wa_sg05413



1-phase	Z-V-AK/1P	104905	10 / 600
2+3-phases	Z-V-AK/2+3P	264930	10 / 600
4-phases	Z-BB-EC/4P ¹⁾	183116	10 / 600

¹⁾ only for Z-SV-16/3P+N-4TE, Article No. 264928

Extension terminals 6 - 25 mm², Z-EK/25

wa_sg02512



long, straight	Z-EK/25	264935	10 / 600
short, straight	Z-EK/25/K	269525	10 / 600
long, crosswise	Z-EK/25/QL	264937	10 / 600
short, crosswise	Z-EK/25/Q	264936	10 / 600











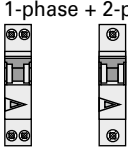

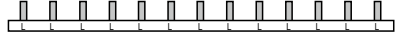

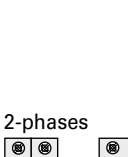

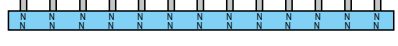
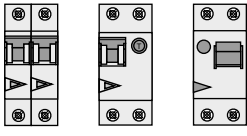

Busbar Tag Shrouds for busbar, yellow ZV-BS-G

SG05705

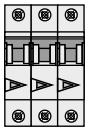

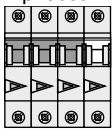
Finger and hand touch safe	ZV-BS-G	104903	10/600
----------------------------	---------	--------	--------

Description of the Busbar Block (Pin) Z-SV

Devices to busbar	Pcs. of the devices	End caps		Type
1-phase + 2-phases 	x13			Z-SV-10/1P-F/13
	x56			Z-SV-16/1P-1TE/F
	x13			Z-SV-10/N-F/13
	x56			Z-SV-16/N-1TE/F
1-phase + 2-phases 	x13			Z-SV-10/1P-1TE/13
	x56			Z-SV-16/1P-1TE
	x13			Z-SV-10/N-1TE/13
	x56			Z-SV-16/N-1TE
2-phases 	x6	Z-V-		Z-SV-10/2P-2TE/13
	x28	AK/2+3P		Z-SV-16/2P-2TE
3-phases 	x56	Z-V-		Z-SV-16/2P+2N-2TE
		AK/2+3P		
3-phases 	x4	Z-V-		Z-SV-10/3P-3TE/13
	x19	AK/2+3P		Z-SV-16/3P-3TE
4-phases 	x3	Z-V-AK/4P		Z-SV-10/3P+N-4TE/12
	x14	Z-BB-EC/4P		Z-SV-16/3P+N-4TE
4-phases 	x13	Z-V-		Z-SV-10/3P+3N-3TE/13
	x56	AK/2+3P		Z-SV-16/3P+3N-3TE

Example

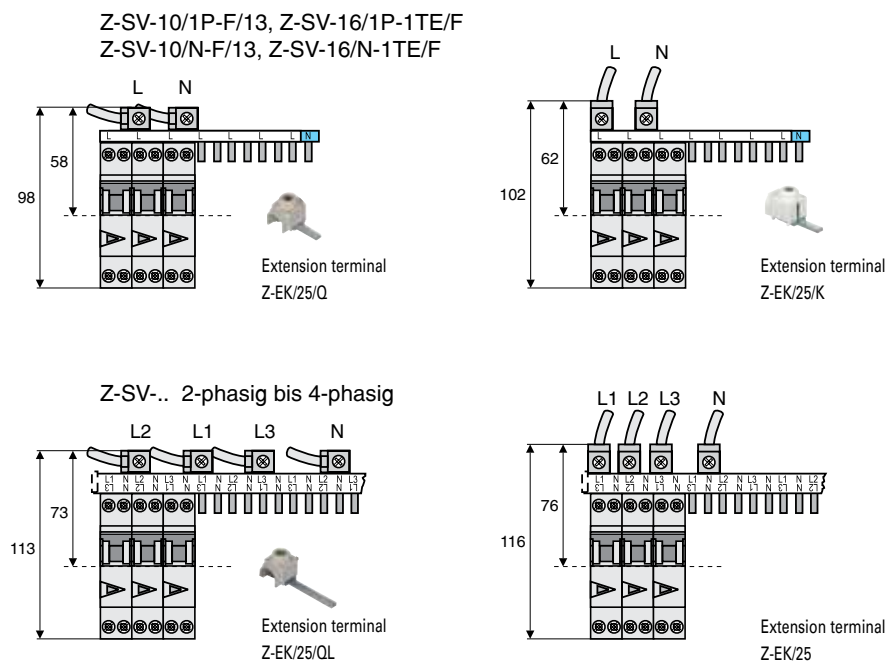

Description Busbar Block 10mm² (Pin) Z-SV-10/, 16mm² (Pin) Z-SV-16/

- Busbar Block 10 mm² delivered with end caps, length 13TE
- Busbar Block 16 mm² without end caps, length 1m

Technical Data

	Z-SV
Electrical	
Rated voltage	240/415 V, 50/60 Hz
Rated current	
10 mm ²	50 A
16 mm ²	63 A
Short-circuit current strength	25 kA
Mechanical	
Busbar cross section	10 and 16 mm ² Cu
Step distance	17.80 mm

Connection diagram

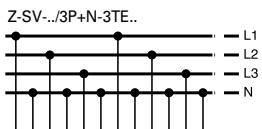

Accessories

SG4800



End caps

WA_SG10702



Extension terminal
Z-EK/25/Q

SG07703



Extension terminal
Z-EK/25/K

WA_SG10702



Extension terminal
Z-EK/25/QL

WA_SG10702



Extension terminal
Z-EK/25

Description	Cu-factor	Type Designation	Article No.	Units per package
-------------	-----------	------------------	-------------	-------------------

Busbar Block 12MU (Fork and Pin) Z-GSV-10

- for PLN. (1MU) + FI
- delivered with end caps

SG4700

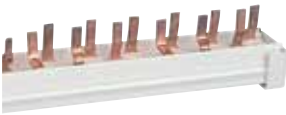

10 mm² - Rated current 50 A

below

2-phases, RCD-2p + 4xPLN	0.07	Z-GSV-10/1P+N-NL/6	274297	10 / 200
2-phases, RCD-2p + 10xPLN	0.131	Z-GSV-10/1P+N/12-U	274299	10 / 100
4-phases, RCD-4p + 4xPLN	0.13	Z-GSV-10/3P+N-NL/8	116858	10
4-phases, RCD-4p + 8xPLN	0.463	Z-GSV-10/3P+N/12-U	274400	10 / 100
4-phases, RCD-4p + 3xPLS. + 5xPLN	0.463	Z-GSV-10/3P+N/12H-U	274401	10 / 100

above

2-phases, RCD-2p + 10xPLN	0.131	Z-GSV-10/1P+N/12-O	274402	10 / 100
4-phases, RCD-4p + 8xPLN	0.463	Z-GSV-10/3P+N/12-O	274403	10 / 100

Description of the Busbar Block 12MU (Fork and Pin) Z-GSV-10

Devices to busbar	Pcs. of the devices	End caps	Type
<p>2-phases</p>	xPLN	Z-V-AK/2+3P	Z-GSV-10/1P+N-NL/6
<p>2-phases</p>	x10	Z-V-AK/2+3P	Z-GSV-10/1P+N/12-O
		Z-V-AK/2+3P	Z-GSV-10/1P+N/12-U
<p>4-phases</p>	5	Z-V-AK/4P	Z-GSV-10/3P+N/12H-U
		Z-V-AK/4P	Z-GSV-10/3P+N/12-O
			Z-GSV-10/3P+N/12-U
<p>4-phases</p>	x8	Z-V-AK/4P	Z-GSV-10/3P+N/12-U
		Z-V-AK/4P	Z-GSV-10/3P+N-NL/8
<p>4-phases</p>	4xPLN	Z-V-AK/4P	Z-GSV-10/3P+N-NL/8

Description Busbar Block 12MU 10mm² (Fork and Pin) Z-GSV-10

- 12MU busbar elements incl. end caps

Technical Data

	Z-GSV-10
Electrical	
Rated voltage	240/415 V, 50/60 Hz
Rated current	50 A
Short-circuit current strength	25 kA
Mechanical	
Busbar cross section	10 mm ² Cu
Step distance	17.95 mm

Connection diagram

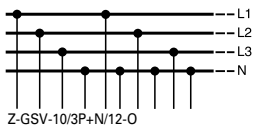

Accessories

WA_SG10702



Extension terminal
Z-EK/25/QL

WA_SG10702



Extension terminal
Z-EK/25

Description	Cu-factor	Type Designation	Article No.	Units per package
-------------	-----------	------------------	-------------	-------------------

Busbar Block 13MU (Fork and Pin) Z-GSV-10

- for 1x RCD + PLG. (1MU)
- Do not cut!! 

wa_sg14303

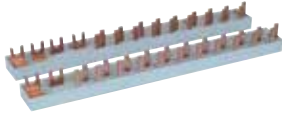

10 mm² - Rated current 63 A

above

2-phases, RCD-2p + 11xPLG	0.251	Z-GSV-10/1P+N-F/13	264920	10
---------------------------	-------	--------------------	--------	----

Description	Type Designation	Article No.	Units per package
-------------	------------------	-------------	-------------------

Accessories

Extension terminals 6 - 25 mm², Z-EK/25

wa_sg02512



long, straight	Z-EK/25	264935	10 / 600
long, crosswise	Z-EK/25/QL	264937	10 / 600

Busbar Tag Shrouds for busbar, yellow ZV-BS-G

SG05705



Finger and hand touch safe	ZV-BS-G	104903	10/600
----------------------------	---------	--------	--------

Description of the Busbar Block 13MU (Fork and Pin) Z-GSV-10

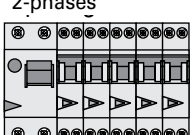
Devices to busbar	Pcs. of the devices	Type
<p>2-phases</p> 	x11	Z-GSV-10/1P+N-F/13

Description Busbar Block 13MU 10mm² (Fork and Pin) Z-GSV-10

- 13MU busbar elements without end caps

Technical Data

Z-GSV-10	
Electrical	
Rated voltage	240/415 V, 50/60 Hz
Rated current	63 A
Short-circuit current strength	25 kA
Mechanical	
Busbar cross section	10 mm ² Cu
Step distance	17.95 mm

Connection diagram

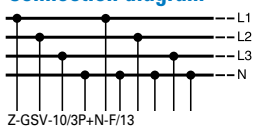

Accessories

<p>WA_SG10602</p>  <p>End caps</p>	<p>WA_SG10702</p>  <p>Extension terminal Z-EK/25/QL</p>	<p>WA_SG10702</p>  <p>Extension terminal Z-EK/25</p>
---	--	---

Description	Cu-factor	Type Designation	Article No.	Units per package
-------------	-----------	------------------	-------------	-------------------

Busbar Block (Pin) Z-SV-../1P+N-F

- for 1x PFGC + PLGC. (1MU)
- 2-phases
- Do not cut!! 



10 mm² - Rated current 50 A

PFGC + 4x PLGC	0.105	Z-SV-10/1P+N-F/6	107944	10 / 100
PFGC + 7x PLGC	0.155	Z-SV-10/1P+N-F/9	107943	10 / 100
PFGC + 11x PLGC	0.22	Z-SV-10/1P+N-F/13	107942	10 / 100

16 mm² - Rated current 63 A

PFGC + 4x PLGC	0.155	Z-SV-16/1P+N-F/6	191245	10 / 100
PFGC + 7x PLGC	0.231	Z-SV-16/1P+N-F/9	191244	10 / 100
PFGC + 8x PLGC	0.259	Z-SV-16/1P+N-F/10	191246	10 / 100
PFGC + 11x PLGC	0.328	Z-SV-16/1P+N-F/13	191243	10 / 100

Description	Type Designation	Article No.	Units per package
-------------	------------------	-------------	-------------------





Accessories

Busbar Tag Shrouds for busbar, yellow ZV-BS-G

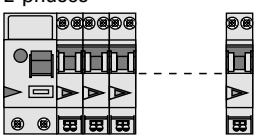

Finger and hand touch safe	ZV-BS-G	104903	10/600
----------------------------	---------	--------	--------

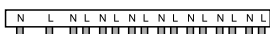
Description of the Busbar Block (Pin) Z-SV-../1P+N-F

Devices to busbar	Pcs. of the devices	Type
2-phases 	x4	 Z-SV-../1P+N-F/6
	x7	 Z-SV-../1P+N-F/9
	x8	 Z-SV-16/1P+N-F/10
	x11	 Z-SV-../1P+N-F/13

Description Busbar Block 10/16mm² (Pin) Z-SV-../1P+N-F

- Busbar elements without end caps

Technical Data

		Z-SV-../1P+N-F
Electrical		
Rated voltage		240/415 V, 50/60 Hz
Rated current		
10 mm ²		50 A
16 mm ²		63 A
Overtoltage category		III
Rated peak withstand voltage	U_{imp}	4 kV
Conditional rated short circuit current AC with 125 A gG		10 kA
Mechanical		
Busbar cross section		10 and 16 mm ² Cu
Step distance		17.8 mm
Flame class according to UL94		V0, glowing wire test 960 °C
Pollution degree		2
Comparative tracking index		CTI 300
Air gap		≥ 5.5 mm
Minimum creepage distance		≥ 5 mm

Connection diagram

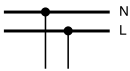

Dimensions (mm)

Z-SV-10/1P+N-F/6, Z-SV-16/1P+N-F/6

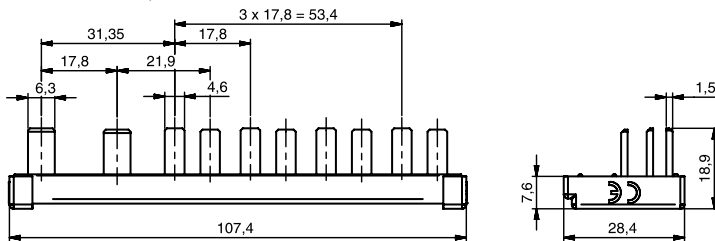

Z-SV-10/1P+N-F/9, Z-SV-16/1P+N-F/9

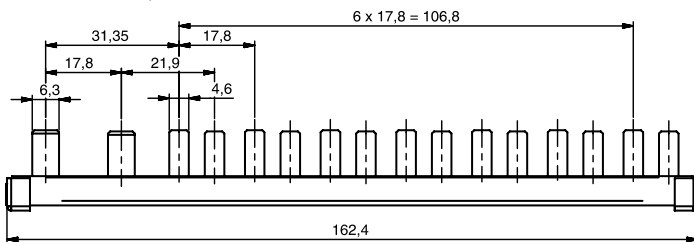

Z-SV-16/1P+N-F/10

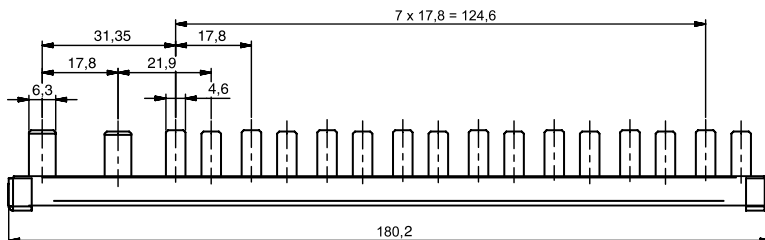

Z-SV-10/1P+N-F/13, Z-SV-16/1P+N-F/13

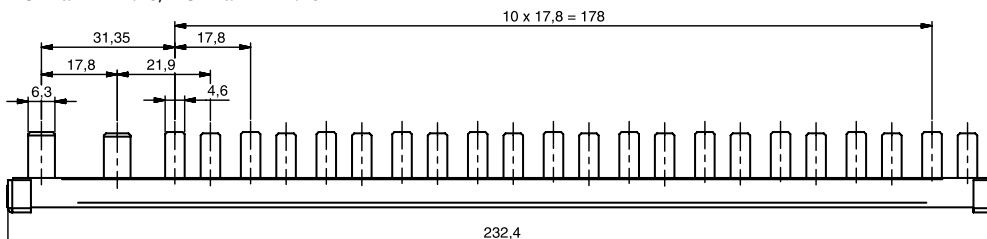

wa_sg03511



Description

- For MCB FAZ-NA/RT
- 16 mm²
- Pin busbar
- Accessories available:
 - Terminals
 - Busbar tag shrouds
- Several length

Description	Step Distance (mm)	Cu-factor	Type Designation	Article No.	Units per package
-------------	--------------------	-----------	------------------	-------------	-------------------

For FAZ-NA/RT, not sliceable!!

- Delivered with end caps

wa_sg03511



16 mm², Rated current 80 A

1-phase, 6MU	17.6	0.035	Z-SV/UL-16/1P-1TE/6	104892	10
1-phase, 12MU	17.6	0.07	Z-SV/UL-16/1P-1TE/12	104893	10
1-phase, 18MU	17.6	0.105	Z-SV/UL-16/1P-1TE/18	104894	10
2-phase, 6MU	17.6	0.07	Z-SV/UL-16/2P-2TE/6	104895	10
2-phase, 12MU	17.6	0.14	Z-SV/UL-16/2P-2TE/12	104896	10
2-phase, 18MU	17.6	0.21	Z-SV/UL-16/2P-2TE/18	104897	10
3-phase, 6MU	17.6	0.14	Z-SV/UL-16/3P-3TE/6	104898	10
3-phase, 12MU	17.6	0.221	Z-SV/UL-16/3P-3TE/12	104899	10
3-phase, 18MU	17.6	0.332	Z-SV/UL-16/3P-3TE/18	104900	10

Accessories

Terminals

SG07506



2,5 - 35mm ²	-	0.035	Z-EK/35/UL	104901	3
1,5 - 50mm ²	-	0.038	Z-EB/50/UL	104902	3

Busbar Tag Shrouds

SG07706



for 3 pins	-	-	ZV-BS-UL	104904	10
------------	---	---	----------	--------	----

Description of UL489-Busbar

Devices to busbar	Pcs. of the devices		Type
<p>1-phase</p>	x6		Z-SV/UL-16/1P-1TE/6
	x12		Z-SV/UL-16/1P-1TE/12
	x18		Z-SV/UL-16/1P-1TE/18
<p>2-phases</p>	x3		Z-SV/UL-16/2P-2TE/6
	x6		Z-SV/UL-16/2P-2TE/12
	x9		Z-SV/UL-16/2P-2TE/18
<p>3-phases</p>	x2		Z-SV/UL-16/3P-3TE/6
	x4		Z-SV/UL-16/3P-3TE/12
	x6		Z-SV/UL-16/3P-3TE/18

Description of the Busbar UL489 Z-SV/UL-16 for FAZ-NA/RT

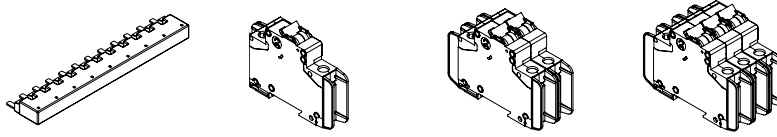

Article No.				
104892	Z-SV/UL-16/1P-1TE/6	6	-	-
104893	Z-SV/UL-16/1P-1TE/12	12	-	-
104894	Z-SV/UL-16/1P-1TE/18	18	-	-
104895	Z-SV/UL-16/2P-2TE/6	-	3	-
104896	Z-SV/UL-16/2P-2TE/12	-	6	-
104897	Z-SV/UL-16/2P-2TE/18	-	9	-
104898	Z-SV/UL-16/3P-3TE/6	-	-	2
104899	Z-SV/UL-16/3P-3TE/12	-	-	4
104900	Z-SV/UL-16/3P-3TE/18	-	-	6
104901	Z-EK/35/UL	-	-	-
104902	Z-EB/50/UL	-	-	-
104904	ZV-BS-UL	-	-	-

Technical Data

		Z-SV/UL16
General		
Heat deflection temperature	125°C - UL94 V0	
Standards		
Busbar	UL489, DIN EN 60947-1, VDE 0660 Teil 100 = IEC 60947-1:2004, IEC 60947-2:2003	
Terminal	IEC 60999:2000, UL489, UL486A, CSA C22.2	
Climate stability	according to DIN EN 60068	
Insulation coordination	Overvoltage category III / Pollution degree 2	
Electrical		
Impulse voltage strenght	≥ 9.5 kV (1 kV / mmLS)	
Min. air distance	> 9.5 mm/25.4 mm (proprietary/external)	
Min. creeping distance	> 12.7 mm/50.8 mm (proprietary/external)	
Max. operating voltage		
1-, 3-phase	690 V IEC 480Y/277V & 240 V AC	
Terminals	1.000 V AC/DC	
Max. busbar current	I _g /Phase	80 A
Protection class	IP20	
Short circuit rating	15 kA mit NH3 355 A gL 500 V JM / 7.5 kA 3 cycles @ 600 V	
Dielectric strenght	>30 kV/mm	

Connection diagram

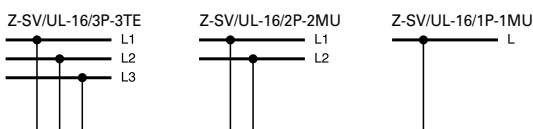

Mounting example of busbar UL489 Z-SV/UL-16 for FAZ-NA/RT

- ! ATTENTION:** Maximum of 3 commoning links allowed. Any combination of same pole configuration.
- ATTENTION:** 3 liaisons communes autorisées au maximum. Toute combinaison de configurations de polarité identiques.
- ACHTUNG:** Maximal 3 Schienenblöcke. Beliebige Kombination gleichpoliger Konfigurationen.
- ATTENZIONE:** Sono consentiti al massimo 3 pettini di collegamento in qualsiasi combinazione della stessa configurazione di poli.
- ATEÏON:** Se permite un máximo de 3 enlaces comunes. Cualquier combinación del mismo tipo de configuración de polo

- ! ~~✂~~ ATTENTION:** Do not cut.
- ATTENTION:** Ne pas couper.
- ACHTUNG:** Nicht durchschneiden.
- ATTENZIONE:** Non tagliare.
- ATEÏON:** No corte.

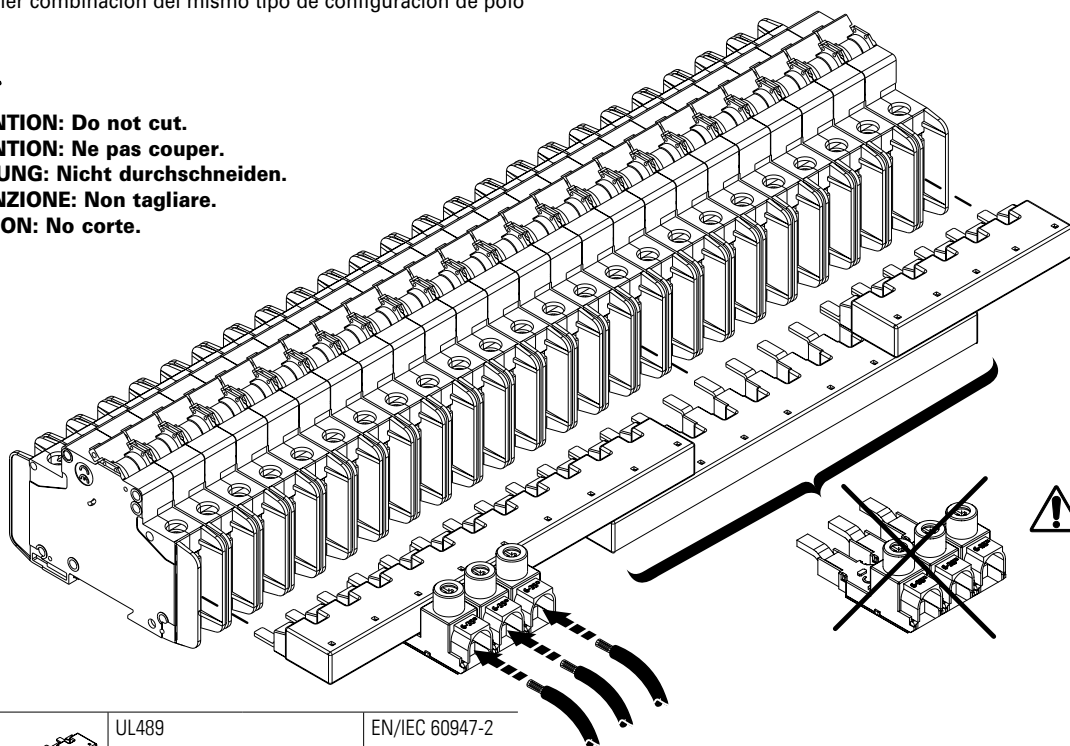

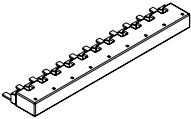
	UL489	EN/IEC 60947-2	
U_e	480 V AC	96 V DC	240/415 V AC
f	50/60 Hz	—	50/60 Hz
U_{imp}	—	—	9,5 kV
I_e	80 A @ 40°C	—	80 A @ 30°C
Terminal capacity	—	—	16 mm ²

Z-EB/50/UL

	UL489	EN/IEC 60947-2	
U_e	480 V AC	96 V DC	240/415 V AC
f	50/60 Hz	—	50/60 Hz
U_{imp}	—	—	9,5 kV

Cross section:

	U - single wire	K - fine wire (with sleeve)	Torque
	R - multi wire	F - fine wire (with sleeve)	
Max. cross section	50 mm ² 1 AWG copper wire	35 mm ² 2 AWG copper wire	4 Nm 35 lbf.in
Min. cross section	1,5 mm ² 14 AWG copper wire		
Busbar-side	Pin max. 5,5x2 / 0.2"x0.07" Länge min. 12,7 mm / Length min. 0.5"		2,5 Nm 22 lbf.in

Z-EK/35/UL

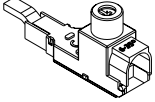
	UL489	EN/IEC 60947-2	
U_e	480 V AC	96 V DC	240/415 V AC
f	50/60 Hz	—	50/60 Hz
U_{imp}	—	—	9,5 kV

Cross section:

	U - single wire	K - fine wire (with sleeve)	Torque
	R - multi wire	F - fine wire (with sleeve)	
Max. cross section	35 mm ² 2 AWG copper wire		5,5 Nm 50 lbf.in
Min. cross section	2,5 mm ² 14 AWG copper wire		

Mounting example of busbar UL489 Z-SV/UL-16 for FAZ-NA/RT

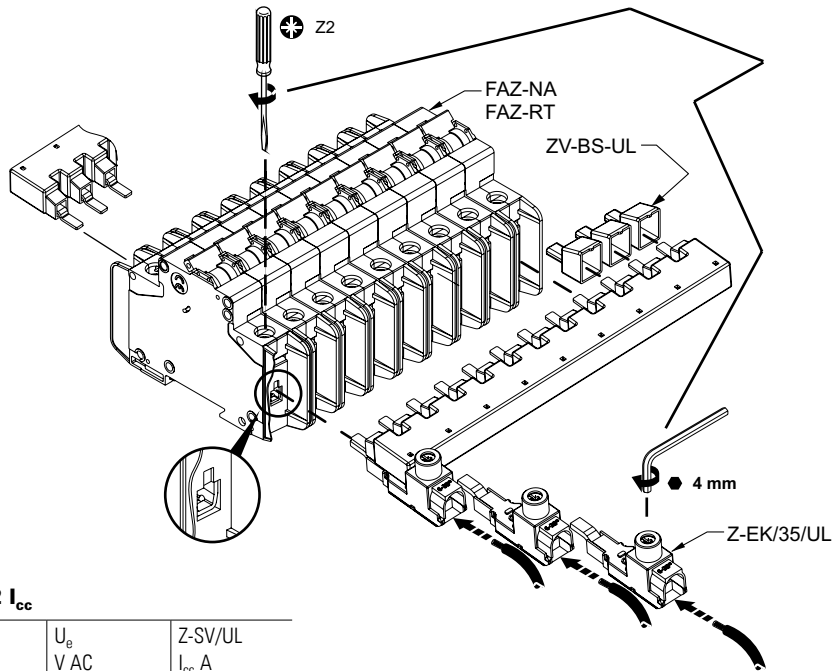

AWG	lb-in	Nm
14	21	2.3
12-8	25	2.8
6-2	36	4.0

IEC/EN 60947-2 I_{cc}

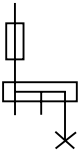
	U _e V AC	Z-SV/UL I _{cc} A
	240/415	15000

UL SCCR

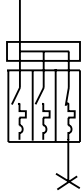
	FAZ-NA FAZ-RT I _n A	U _e V AC	Z-SV/UL SCCR RMS Sym A
	0.5-32	480Y/277	10000
	35-40	240	10000

Dimensions (mm)

Z-SV/UL-16/TE/6

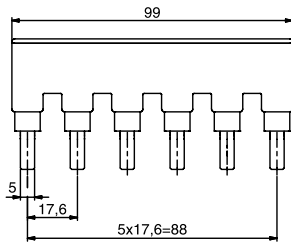

Z-SV/UL-16/TE/12

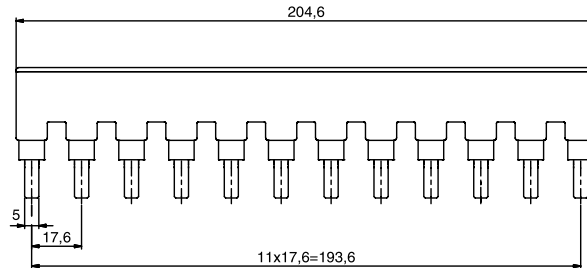

ZV-BS-UL

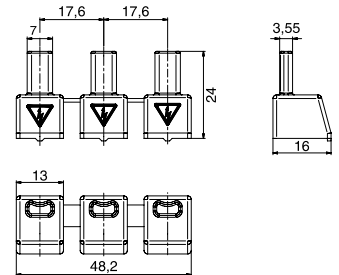

Z-SV/UL-16/TE/18

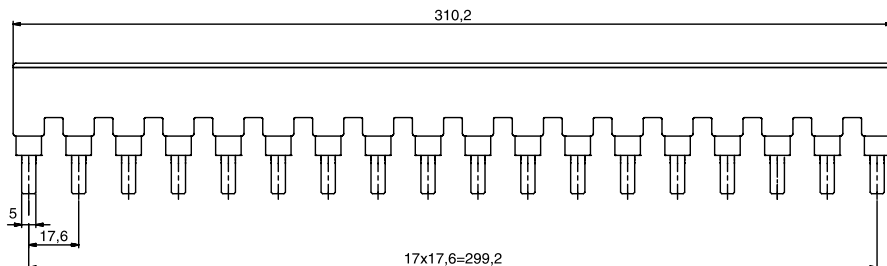

Z-EK/35/UL

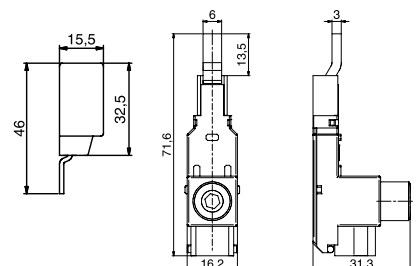

Example

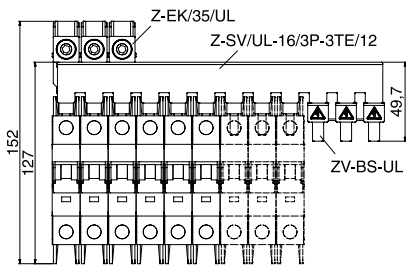

Z-EK/35/UL

	UL489	IEC/EN60947-2
	# 2-14 AWG 60/75 °C Cu	2.5-35 mm ² Cu
	0.56 in	14 mm
testet acc. to		Tightening torque
UL486A	# 14 AWG	≥ 2.3 Nm
UL486B	# 8-12 AWG	≥ 2.8 Nm
UL486E	# 6-1 AWG	4 Nm

Description	Cu-factor	Type Designation	Article No.	Units per package
-------------	-----------	------------------	-------------	-------------------

Busbar Block (Pin) Z-SV

- delivered without end caps

Busbar Block (Pin) Z-SV-16/3P

- for Z-SLS, PLHT, DO.-SO/.. (1.5MU)

wa_sg03611

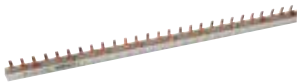

16 mm² - Rated current 80 A

3-phases	0.84	Z-SV-16/3P	271072	20
----------	------	------------	--------	----

Accessories for Z-SV-16/3P

Extension terminal

wa_sg05913



Extension terminal 6-50 mm ²		Z-EK/50	264934	3 / 180
---	--	---------	--------	---------

End cap

SG4800



End cap		Z-V-35/AK/3P	264932	10 / 600
---------	--	--------------	--------	----------

Busbar Block (Pin) Z-SV-35

- for Z-SLS, PLHT, DO.-SO/.. (1.5MU), PLHT-V (1.5MU)

wa_sg03711

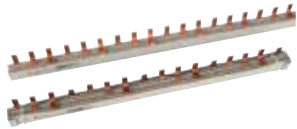

35 mm² - Rated current 110 A

1-phase angulated grey	0.83	Z-SV-35/1P	113135	1
3-phases	2.74	Z-SV-35/3P	264938	4
3-phases	2.74	Z-SV-35/PLHT-V	264939	4
4-phases*	1.57	Z-SV-35/3P+N-6TE	263110	4

* delivered with end caps

Accessories for Z-SV-35

End cap

SG4800



End cap		Z-V-35/AK/3P	264932	10 / 600
---------	--	--------------	--------	----------

Accessories for Z-SV-35

Extension terminals Z-EK/95

- 25-95 mm² single-/multi-wire
- 16-70 mm² fine wires with wire end sleeve
- Max. tightening torque: 19 Nm

wa_sg05513



for Z-SV-35/1P		Z-EK/95-1	113136	3 / 90
for Z-SV-... 3-phases		Z-EK/95	264933	3 / 90
for Z-SV-35/3P+N		Z-EK/95-3N	264911	4 / 120

Description of the Busbar Block (Pin) Z-SV

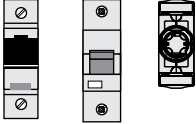
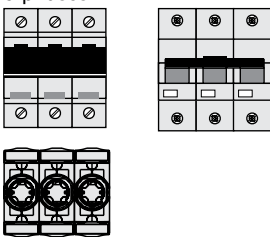
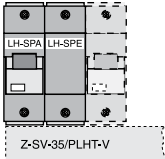
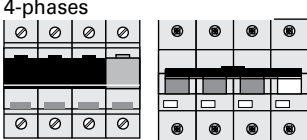
Devices to busbar	Pcs. of the devices	End caps	Type
<p>1-phase</p> 	x36		Z-SV-35/1P
<p>3-phases</p> 	x12	<p>Z-AK-16/2+3P</p> <p>Z-V-35AK/3P</p>	<p>Z-SV-16/3P</p> <p>Z-SV-35/3P</p>
	x33	Z-V-35AK/3P	Z-SV-35/PLHT-V
<p>4-phases</p> 	x4	Z-V-35AK/3P	Z-SV-35/3P+N-6TE

Description Busbar Block (Pin) Z-SV

- End caps are to be ordered separately, exception Z-SV-35/3P+N-6TE
- Halogenfree plastic

Technical Data

	Z-SV-16	Z-SV-35
Electrical		
Rated operational voltage	240/415 V AC	240/415 V AC
Rated frequency	50/60 Hz	50/60 Hz
Rated voltage	500 V	690 V
Overvoltage category	III	III
Rated peak withstand voltage	U_{imp} 4 kV	6 kV
Rated current	80 A	110 A
Conditional rated short circuit current AC with 250 A gG	50 kA _{r.m.s.}	100 kA _{r.m.s.}
Mechanical		
Busbar cross section	16 mm ² Cu	35 mm ² Cu
Step distance	27 mm	27 mm (Z-SV-35/PLHT-V 30.5 mm)
Flame class according to UL94	V0, glowing wire test 960 °C	V0, glowing wire test 850 °C
Degree of protection, with end caps	IP20	IP20
Pollution degree	2	2
Comparative tracking index	CTI 300	CTI 600
Air gap	≥ 5 mm	≥ 4.3 mm
Minimum creepage distance	≥ 10.2 mm	≥ 6.7 mm

Dimensions (mm)

	n	A	B	C	D	E	F	G	H	I
Z-SV-16/3P	35	27	5	945	971	14.9	31	1.5	17	19
Z-SV-35/3P	35	27	8.5	945	1000	19.7	38.4	2.5	21.5	23.9
Z-SV-35/PLHT-V	32	30.5	8.5	976	1000	19.7	38.4	2.5	21.5	23.9

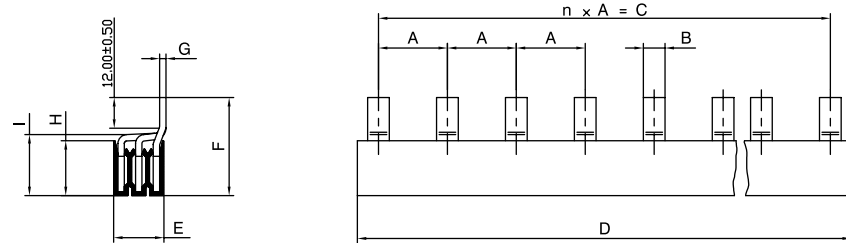

Accessories for Z-SV-16

Wa_sg10802



Extension terminal
Z-EK/50

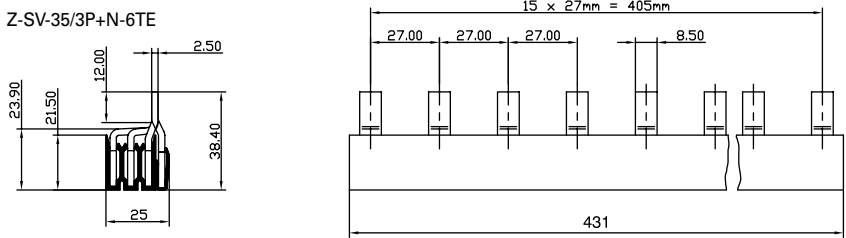

Accessories for Z-SV-35

Wa_sg10802



Extension terminal
Z-EK/95, Z-EK/95-3N,
Z-EK/95-1

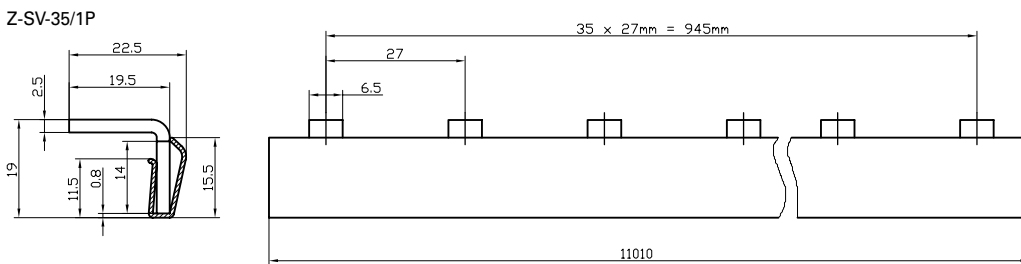

Phases	MU	Cu-factor	Type Designation	Article No.	Units per package
--------	----	-----------	------------------	-------------	-------------------

Euro-Vario-Busbar (Fork) EVG

- for PLS., PKN., PFIM, PFHM, PFNM
- no end caps necessary
- Do not cut!! 

10 mm² - Rated current 63 A

1- to 4-phases

1-phase	2	0.015	EVG-1PHAS/2MODUL	215646	40 / 800
1-phase	6	0.039	EVG-1PHAS/6MODUL	215638	40 / 800
1-phase	12	0.046	EVG-1PHAS/12MODUL	215637	40 / 400
2-phases	4	0.051	EVG-2PHAS/4MODUL	268220	20 / 400
2-phases	6	0.079	EVG-2PHAS/6MODUL	215642	20 / 400
2-phases	12	0.150	EVG-2PHAS/12MODUL	215641	20 / 200
3-phases	6	0.086	EVG-3PHAS/6MODUL	215640	20 / 400
3-phases	9	0.128	EVG-3PHAS/9MODUL	215645	20 / 200
3-phases	12	0.168	EVG-3PHAS/12MODUL	215639	20 / 200
3-phases	16	0.230	EVG-3PHAS/16MODUL	285381	20
3-phases	20	0.310	EVG-3PHAS/20MODUL	285383	20 / 180
3-phases	12	0.240	EVG-3P+3N/12MODUL	121091	20
4-phases	16	0.320	EVG-3P+3N/16MODUL	105215	20
4-phases	18	0.350	EVG-3P+3N/18MODUL	274161	20
4-phases	8	0.219	EVG-4PHAS/8MODUL	215644	10 / 100
4-phases	12	0.324	EVG-4PHAS/12MODUL	215643	10 / 100

Wa_sg02902

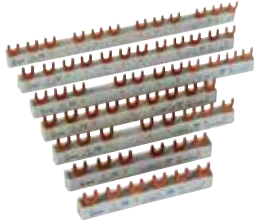

For 2-pole Combined RCD/MCB Device with a width of 3MU

1-phase	2-5	0.045	EVG-1PHAS/N/2-5MODUL/FILS	285384	40 / 800
---------	-----	-------	---------------------------	--------	----------

For combination RCD/MCBs with RCD 4-pole

3-phases	4+5	0.138	EVG-3PHAS/N/5MODUL/LS	215659	20 / 200
3-phases	4+8	0.188	EVG-3PHAS/N/8MODUL/LS	215660	20 / 200

Wa_sg01602

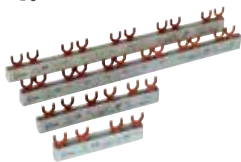

For applications with Auxiliary Switch

1-phase	2.5	0.008	EVG-1PHAS/2MODUL/HI	215655	40 / 200
1-phase	13	0.096	EVG-1PHAS/9MODUL/HI	215656	40
2-phases	4.5	0.015	EVG-2PHAS/4MODUL/HI	219573	20 / 400
2-phases	12	0.160	EVG-2PHAS/10MODUL/HI	215657	20
3-phases	6.5	0.100	EVG-3PHAS/6MODUL/HI	216411	20 / 200
3-phases	13.5	0.200	EVG-3PHAS/12MODUL/HI	215658	20

16 mm² - Rated current 80 A

1- to 4-phases

1-phase	2	0.023	EVG-16/1PHAS/2MODUL	291464	40 / 800
1-phase	6	0.059	EVG-16/1PHAS/6MODUL	291465	40 / 800
1-phase	12	0.113	EVG-16/1PHAS/12MODUL	291466	40 / 400
2-phases	4	0.080	EVG-16/2PHAS/4MODUL	291467	20 / 400
2-phases	6	0.120	EVG-16/2PHAS/6MODUL	291468	20 / 400
2-phases	12	0.225	EVG-16/2PHAS/12MODUL	291469	20 / 200
3-phases	6	0.112	EVG-16/3PHAS/6MODUL	291470	20 / 400
3-phases	9	0.163	EVG-16/3PHAS/9MODUL	291471	20 / 200
3-phases	12	0.218	EVG-16/3PHAS/12MODUL	291472	20 / 200
3-phases	16	0.300	EVG-16/3PHAS/16MODUL	291473	20 / 80
3-phases	20	0.363	EVG-16/3PHAS/20MODUL	291474	10 / 100
4-phases	8	0.200	EVG-16/4PHAS/8MODUL	291475	10 / 100
4-phases	12	0.284	EVG-16/4PHAS/12MODUL	291476	10 / 100

Wa_sg02902

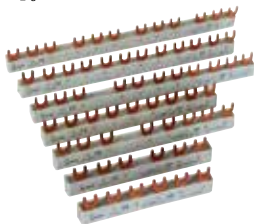

Phases	MU	Cu-factor	Type Designation	Article No.	Units per package
--------	----	-----------	------------------	-------------	-------------------

For 2-pole Combined RCD/MCB Device with a width of 3MU

4-phases	18	0.260	EVG-16/4PHAS/L-N-X/6PC	116880	10
4-phases	24	0.360	EVG-16/4PHAS/L-N-X/8PC	116881	10

For combination RCD/MCBs with RCD 4-pole

3-phases	4+5	0.179	EVG-16/3PHAS/N/5MODUL/LS	291477	20 / 200
3-phases	4+8	0.244	EVG-16/3PHAS/N/8MODUL/LS	291478	20 / 200

Wa_sg01602

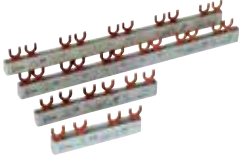

For applications with Auxiliary Switch

1-phase	2.5	0.038	EVG-16/1PHAS/2MODUL/HI	291479	40 / 800
1-phase	8.5	0.105	EVG-16/1PHAS/6MODUL/HI	291480	40 / 400
1-phase	13	0.162	EVG-16/1PHAS/9MODUL/HI	291481	40 / 160
2-phases	4.5	0.080	EVG-16/2PHAS/4MODUL/HI	291482	20 / 400
2-phases	7	0.120	EVG-16/2PHAS/6MODUL/HI	291483	20 / 200
2-phases	12	0.200	EVG-16/2PHAS/10MODUL/HI	291484	20 / 200
3-phases	6.5	0.130	EVG-16/3PHAS/6MODUL/HI	291485	20 / 200
3-phases	13.5	0.260	EVG-16/3PHAS/12MODUL/HI	291486	20 / 80
3x1-phase	8.5	0.231	EVG-16/3x1PHAS/6MODUL/HI	291487	20 / 200
3x1-phase	11.5	0.300	EVG-16/3x1PHAS/8MODUL/HI	291488	20 / 200
3x1-phase	13	0.344	EVG-16/3x1PHAS/9MODUL/HI	291489	20 / 80





Description Euro-Vario-Busbar (Fork) EVG

- Euro Vario busbars (EVG) offer maximum user comfort and a high degree of safety.
- Using EVG busbars helps to save up to 30 % assembly time as compared to conventional systems.
- The danger of flashover is minimised since there is no need of cutting, burring, or cleaning.
- No end caps are needed.

Technical Data

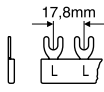
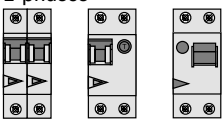
	EVG
Electrical	
Rated voltage	240/415 V, 50/60 Hz
Rated current	
10 mm ²	63 A
16 mm ²	80 A
Short-circuit current strength	25 kA
Mechanical	
Busbar length	2, 6, 9, 12, 16, 20 MU
Busbar cross section	10 and 16 mm ² Cu
Step distance	
10 mm ²	17.8 mm / 26.8 mm / 71.2 mm
16 mm ²	17.8 mm / 27 mm / 71.2 mm

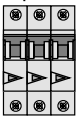
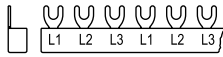
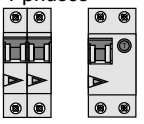
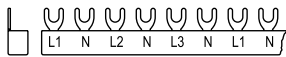
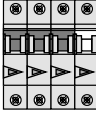
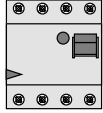
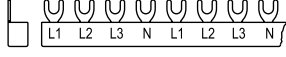
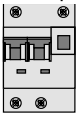
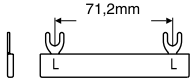
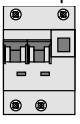
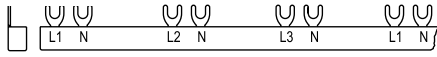
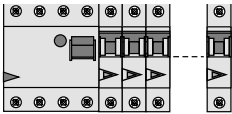
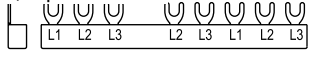
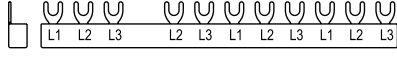
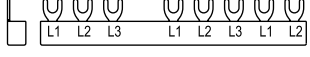
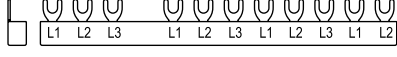
Description of Euro-Vario-Busbar (Fork) EVG

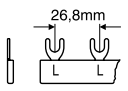
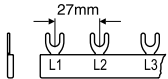
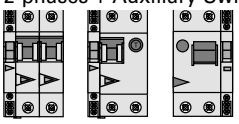
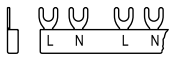
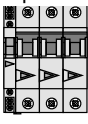
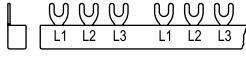
Devices to busbar	Pcs. of the devices		Type
<p>1-phase</p> 	<p>x2 x6 x12</p>		<p>EVG-../1PHAS/2MODUL EVG-../1PHAS/6MODUL EVG-../1PHAS/12MODUL</p>
<p>2-phases</p> 	<p>x2 x3 x6</p>		<p>EVG-../2PHAS/4MODUL EVG-../2PHAS/6MODUL EVG-../2PHAS/12MODUL</p>
<p>3-phases</p> 	<p>x2 x3 x4 x5 x6</p>		<p>EVG-../3PHAS/6MODUL EVG-../3PHAS/9MODUL EVG-../3PHAS/12MODUL EVG-../3PHAS/16MODUL EVG-../3PHAS/20MODUL</p>
<p>4-phases</p> 	<p>x8 x9</p>		<p>EVG-3P+3N/16MODUL EVG-3P+3N/18MODUL</p>
 	<p>x2 x3</p>		<p>EVG-../4PHAS/8MODUL EVG-../4PHAS/12MODUL</p>
<p>For 2-pole Combined RCD/MCB Device, 1-phase</p> 	<p>x2</p>		<p>EVG-1PHAS/2-5MODUL/FILES</p>
<p>For 2-pole Combined RCD/MCB Device, 4-phases</p> 	<p>x6 x8</p>		<p>EVG-16/4PHAS/L-N-X/6PC EVG-16/4PHAS/L-N-X/8PC</p>
<p>For combination RCD/MCBs with RCD 4-pole, 3-phases</p> 			<p>EVG-3PHAS/N/5MODUL/LS</p>
			<p>EVG-3PHAS/N/8MODUL/LS</p>
			<p>EVG-16/3PHAS/N/5MODUL/LS</p>
			<p>EVG-16/3PHAS/N/8MODUL/LS</p>
<p>1-phase + Auxiliary Switch</p> 	<p>x2 x6 x9</p>		<p>EVG-../1PHAS/2MODUL/HI EVG-16/1PHAS/6MODUL/HI EVG-../1PHAS/9MODUL/HI</p>
	<p>x6 x8 x9</p>		<p>EVG-16/3x1PHAS/6MODUL/HI EVG-16/3x1PHAS/8MODUL/HI EVG-16/3x1PHAS/9MODUL/HI</p>
<p>2-phases + Auxiliary Switch</p> 	<p>x2 x3 x5</p>		<p>EVG-../2PHAS/4MODUL/HI EVG-16/2PHAS/6MODUL/HI EVG-../2PHAS/10MODUL/HI</p>
<p>3-phases + Auxiliary Switch</p> 	<p>x2 x4</p>		<p>EVG-../3PHAS/6MODUL/HI EVG-../3PHAS/12MODUL/HI</p>

WA_REN_SG_01622_L, WA_REN_SG_01722_R, WA_REN_SG_01822_C

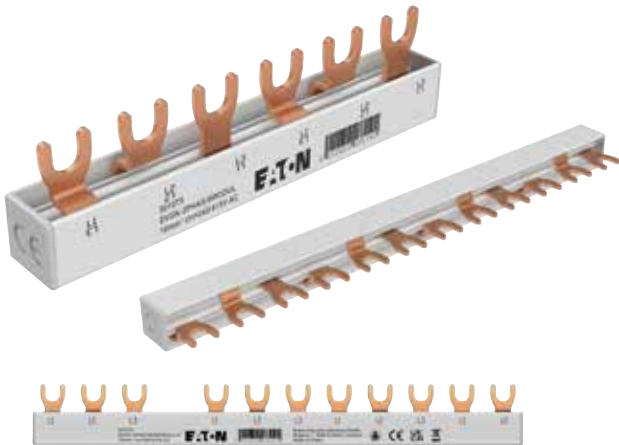

Description

- Available in 10 mm² cross section
- Fork type
- Comes with end caps
- Busbar can be cut to desired length
- End caps can be ordered separately as replacement

Phases	MU	Cu-factor	Type Designation	Article No.	Units per package
--------	----	-----------	------------------	-------------	-------------------

Euro-Vario-Busbar (Fork) EVGK

10 mm² - Rated current 63 A

WA_REN_SG_01622_L



3-phases	6	0.026	EVGK-3PHAS/6MODUL	501075	20 / 400
3-phases	12	0.068	EVGK-3PHAS/12MODUL	501069	20 / 200

WA_REN_SG_01822_L



For combination RCD/MCBs with RCD 4-pole

3-phases	4+8	0.065	EVGK-3PHAS/N/8MODUL/LS	501070	20 / 400
----------	-----	-------	------------------------	--------	----------

Description	Type Designation	Article No.	Units per package
-------------	------------------	-------------	-------------------

Accessories

WA_REN_SG_00822_L



End cap 3-phases (10 mm ²)	EK-3/10-EVGK-GVK	501076	10 / 5000
--	------------------	--------	-----------

Description	Type Designation	Article No.	Units per package
-------------	------------------	-------------	-------------------

Accessories

Busbar Tag Shrouds for busbar, yellow ZV-BS-G

SG05705



Finger and hand touch safe	ZV-BS-G	104903	10 / 600
----------------------------	---------	--------	----------

Technical Data

EVGK	
General	
Standards	DIN EN 61439-1:2021-10 / DIN EN 61439-6:2013-06 IEC 664 / IEC 60895-2-12 / VDE 0110 / DIN EN 60754-1
Climate stability	according to IEC 68-2
Overtoltage category	III
Pollution Degree	2
Busbar Material	E-Cu-ETP
Isolation Material	PC-ABS
Endcap Material	PC-ABS
Touch protection Material	PP
Electrical	
Rated operating voltage	400 V AC
Rated current	
10 mm ²	63 A
16 mm ²	80 A
Short-circuit current strength	25 kA /100 A gl
Disruptive Strength	36 kV/mm
Surge Voltage	U_{imp} 4 kV
Mechanical	
Busbar cross section	10 mm ²
Step distance	17.8 mm

Feeding

Side Feeding

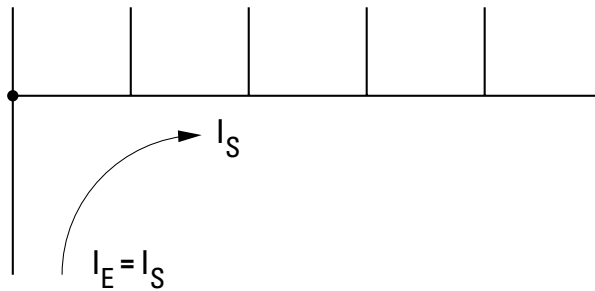

Central Feeding

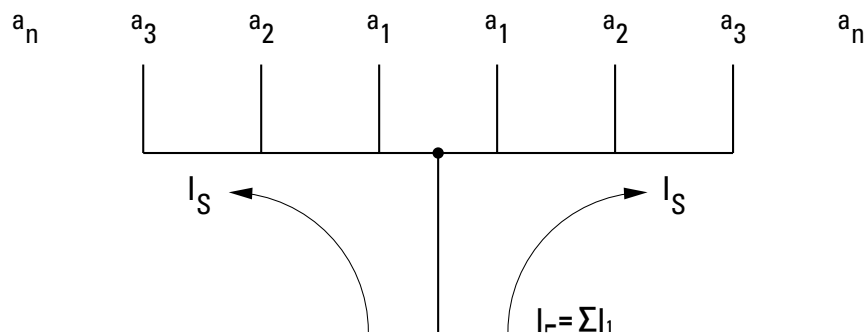

Using central supply feeding you must be sure that the sum of the output current depending on $a_1 \dots a_n$ of each busbar part is not greater than the above max. busbar current I_s / phase

Connection diagram

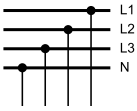

Description Graphics

Devices to busbar	Pcs. of the devices	End caps		Type
<p>3-phases</p>	x2	EK-3/10-EVGK-GVK		EVGK-3PHAS/6MODUL
	x4			EVGK-3PHAS/12MODUL
<p>For combination of RCD/MCBs. 4+8 MU</p>		EK-3/10-EVGK-GVK		EVGK-3PHAS/N/8MODUL/LS

Dimensions (mm)

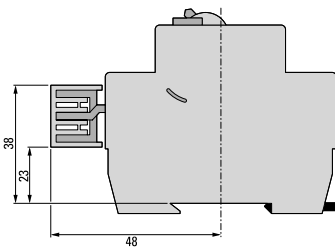

End Cap dimensions (mm)

EK-3/10-EVGK-GVK

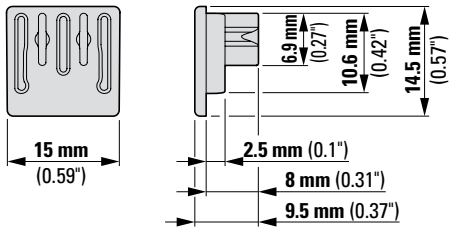

EK-3/16-EVGK-GVK

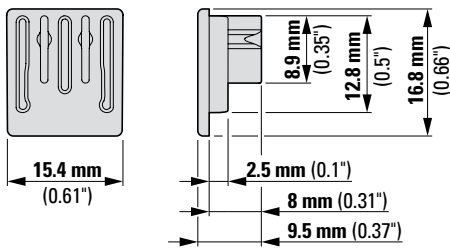

EK-3N/16-EVGK-GVK

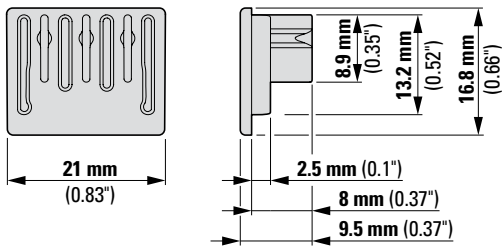

Dimensions (mm)

EVGK-3PHAS/6MODUL

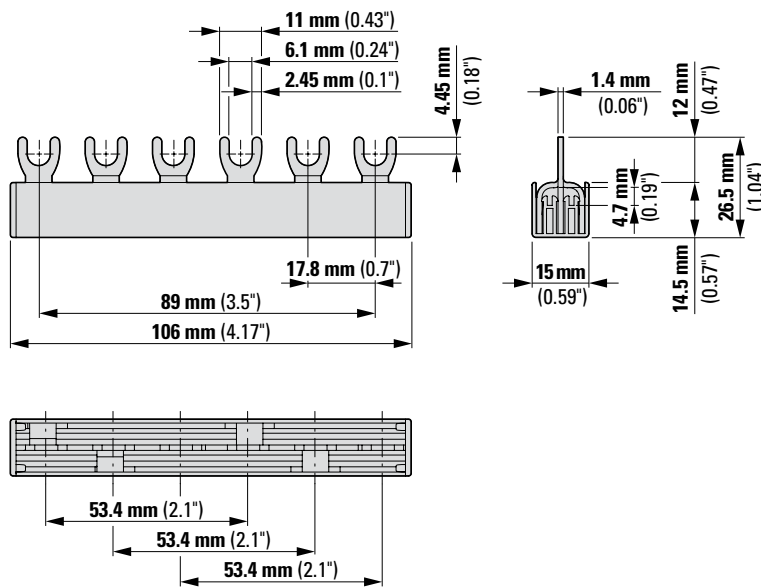

wa_sg02616



Description	Type Designation	Article No.	Units per package
Vertical Busbar 16mm² BB-V-16/1P+N			
2-phases	BB-V-16/1P+N	186887	5

wa_sg02616



Description Vertical Busbar 16mm² BB-V-16/1P+N

Attention:

The thermal overload protection for the RCCB installing next to the vertical busbar must be considered (please refer to our catalogue register RCCB

$I_n = 16A$ RCCB \Rightarrow 10 A gG/gL Fuse/Main Incomer

$I_n = 25-40A$ RCCB \Rightarrow 25 A gG/g Fuse/Main Incomer

$I_n = 63A$ RCCB \Rightarrow 40 A gG/gL Fuse/Main Incomer

or country specific wiring regulations).

The thermal emission from the vertical busbar can affect the tripping characteristics of the neighboring RCDs, please follow notes in our product documentation regarding possible temperature derating.

Thermal overload protection for the vertical busbar according to EN61439-3 must be considered \Rightarrow nominal current 80A, max. 84A for 15 minutes, maximum setting for ELCB NF: 60A.



Products are EU conform and correspond to the RoHS of the EU

Technical Data

		BB-V-16/1P+N
General		
Busbar		Copper
Surface busbar		plain
Insulation		PA66
Surface insulation		grey RAL 7035
Standards		EN 60947-1:2007 / IEC 60947-1:2007
Temperature resistance		125 °C – UL94 V0
CTI Insulation		600 V
Insulation coordination		Overvoltage category III / Pollution degree 2
Electrical		
Max. electrical load		690 V AC
Protection class		IP20
Rated peak withstand voltage	U_{imp}	6 kV
Rated insulation voltage	U_i	800 V
Capacity at 35 °C ambient temperature		
Max. current with bar cross section 16 mm ²	I_g /Phase	80 A

Dimensions (mm)

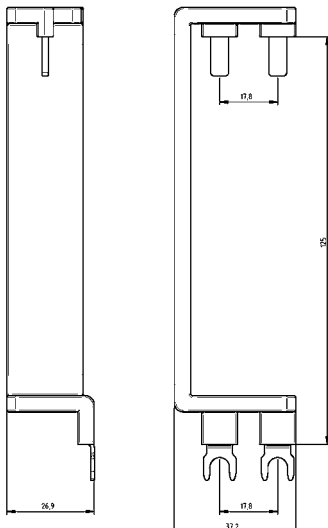

sg05517



Phases	Cu-factor	Type Designation	Article No.	Units per package
2-phase	0.114	EVG-2PHAS/4AFDD	193378	10



Technical Data



Products are EU conform and correspond to the RoHS of the EU

EVG-2PHAS/4AFDD	
General	
Busbar	Copper
Surface busbar	plain
Insulation	PC/ABS
Surface insulation	grey
Standards	EN 60947-1:2007 / IEC 60947-1:2007
Heat deflection temperature	90 °C – UL94 V0
Glow Wire Flammability Index	960 °C / 1 mm
Insulation coordination	Overvoltage category III / Pollution degree 2
Electrical	
Max. operating voltage	690 V AC/DC
Protection class	IP20
Rated impulse withstand voltage	$U_{imp} \geq 4,5 \text{ kV}$
Max. operating voltage	690 V IEC
1-, 3-phase	480Y/277V & 240 V AC
Load Capacity at 35 °C ambient temperature depending of feeding point	
Max. busbar current feeding at beginning / ending	$I_g/\text{Phase} \ 50 \text{ A}$
Busbar cross section	10 mm ²
Connection cross section	10 mm ²

Dimensions (mm)

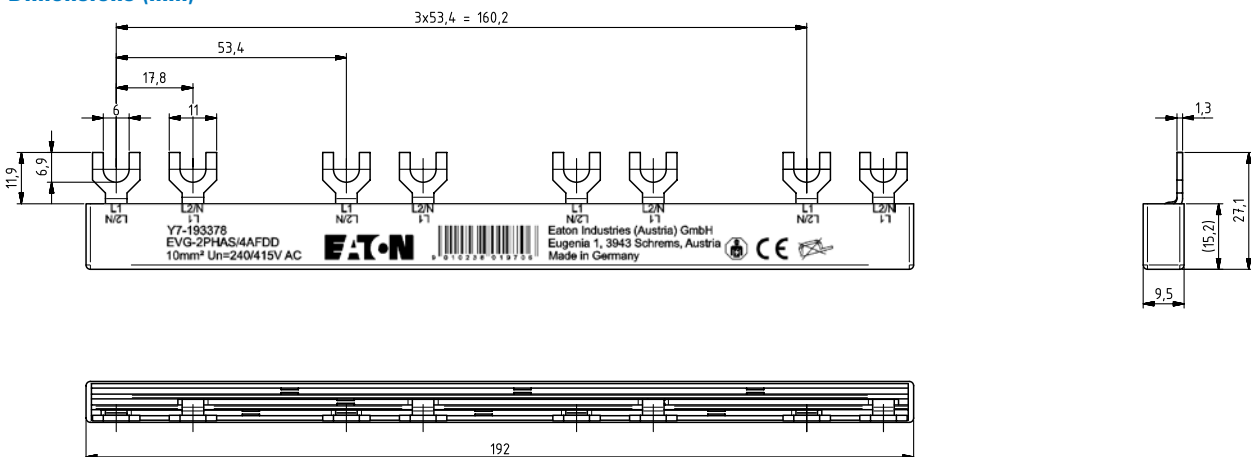

Description	Type Designation	Article No.	Units per package
-------------	------------------	-------------	-------------------

Busbar for auxiliary contact

sg00121, sg00221, sg00621

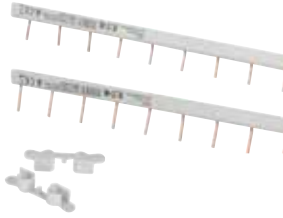

4 mm ²			
Short pin	Z-VPS-4/1p+HS	302375	20/200
Long pin	Z-VPL-4/1p+HS	302376	20/200
End cap	Z-VP-AK/1p	302377	10/500

Description Busbar 4 mm²



Products are CE conform and correspond to the RoHS of the EU

Technical Data

Z-VPS / Z-VPL	
General	
Busbar	Copper
Surface busbar	plain
Insulation	PC/ABS
Surface insulation	grey
Standards	EN 60947-1:2007 / IEC 60947-1:2007
Heat deflection temperature	90 °C flame-retardant
Comparative Tracking Index	PLC 1
Insulation coordination	Overvoltage category III / Pollution degree 2
Electrical	
Max. operating voltage	1000 V AC / 1500V DC
Protection class	IP20

Load Capacity at 35 °C ambient temperature depending of feeding point

Max. busbar current feeding at beginning / ending	I _s /Phase 32 A
Busbar cross section	4 mm ²

Dimensions (mm)

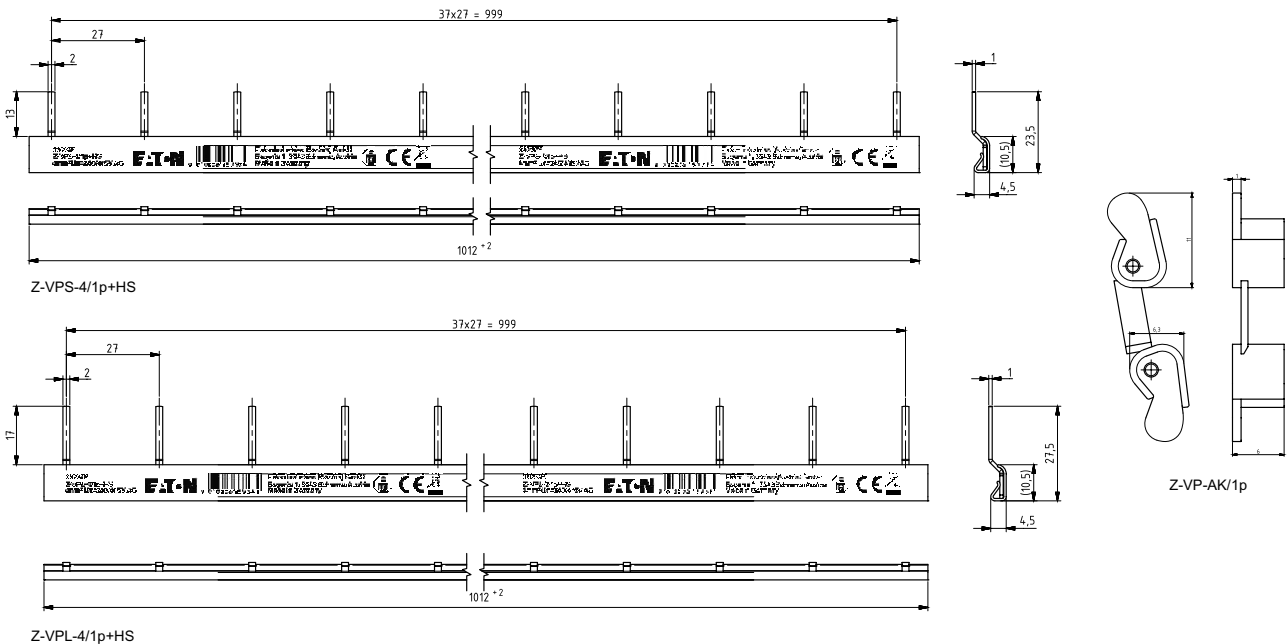

1.144 Busbar Systems

Busbar Z-VPS, Z-VPL for auxiliary contact

Connection examples

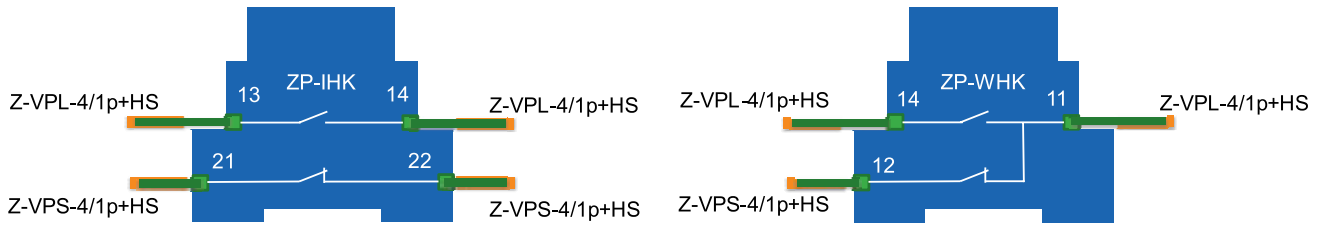

Phases	Cu-factor	Type Designation	Article No.	Units per package
--------	-----------	------------------	-------------	-------------------

Busbar EVG-3PHAS/N/6MODUL/LS

sg00321



10 mm², 16 mm², 25 mm²				
3-phases		EVG-3PHAS/N/6MODUL/LS	303366	10

Description Busbar EVG-3PHAS/N/6/MODUL/LS



Products are EU conform and correspond to the RoHS of the EU

Technical Data

EVG3/PHAS/N/6/MODUL/LS	
General	
Busbar	Copper
Surface busbar	plain
Insulation	PC/ABS
Surface insulation	grey
Standards	EN 60947-1:2007 / IEC 60947-1:2007
Temperature resistance	90 °C flammgeschützt
CTI Insulation	300 V
Insulation coordination	Overvoltage category III / Pollution degree 2
Electrical	
Impulse voltage strenght	≥ 4.5 kV
Min. air distance	> 5.5 mm
Min. creeping distance	> 5 mm
Max. operating voltage	1Ph: 1000V AC/DC 2Ph-4Ph : 690 V AC/DC
Protection class	IP20
Short circuit rating	ICC 15 kA - NH3 250 A gC500V JM
Dielectric strenght	> 32 kV / mm

Load Capacity at 35 °C ambient temperature depending of feeding point

Busbar cross section	10 mm ²	16 mm ²	25 mm ²
Feeding at beginning / ending			
Max. busbar current I _g /Phase	63 A	80 A	100 A
Connection cross section mm ²	10 mm ²	16 mm ²	25 mm ²

Dimensions (mm)

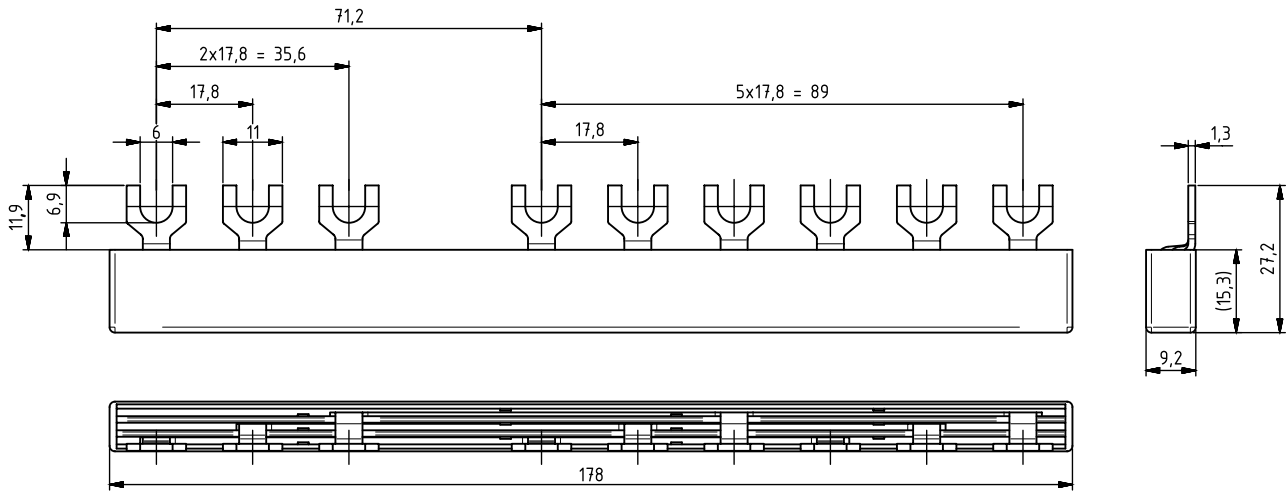

Poles	Type Designation	Article No.	Units per package
-------	------------------	-------------	-------------------

Row-connectors-system for compact distribution boards with 125 mm row spacing



1	RVS-1PHAS/125	215610	3
N	RVS-1N/125	215612	3
1+N	RVS-1PHAS+N/125	215615	3
3	RVS-3PHAS/125	215617	3
3+N	RVS-3PHAS+N/125	215620	3

Row-connectors-system for distribution boards with 150 mm row spacing



1	RVS-1PHAS/150	215611	3
N	RVS-1N/150	215613	3
1+N	RVS-1PHAS+N/150	216410	3
3	RVS-3PHAS/150	215618	3
3+N	RVS-3PHAS+N/150	215621	3

Row-connectors-system for connections across 2 rows with 125 mm row spacing

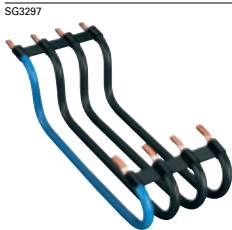

1	RVS-1PHAS/250	216409	3
N	RVS-1N/250	215614	3
1+N	RVS-1PHAS+N/250	215616	3
3	RVS-3PHAS/250	215619	3
3+N	RVS-3PHAS+N/250	215622	3

Specification | Rigid Row Connectors

Description

The row connectors offer the greatest possible application comfort with the highest level of safety. The use of the row connectors results in a large saving of assembly time compared to conventional systems.

The rigid row connectors are used for the safe distribution of phases to several DIN rail rows. Thanks to the flattened connection pieces, two rigid wiring bridges can be fed into one lift terminal at the same time.

The row connectors can be folded up between the individual phases thanks to the flexible retaining bridges and can therefore also be used in extremely flat distribution boards.

If required, the row connectors can also be easily separated at these distance holders.

Technical Data

	RVS
Electrical	
Standards and regulations	IEC 60664
Rated voltage	max. 500 V
Capacity	max. 120 A
Short circuit rating	25 kA
Mechanical	
Length	125, 150, 250 mm
Phase indication labels available	Phase black, N-conductor blue, earth conductor yellow/green
Conductor material	Copper
Terminal protection	finger and hand touch safe according to DGUV VS3, EN 50274
Ambient temperature	-20°C to +40°C
Resistance to climatic conditions	according to IEC 60068

Dimensions (mm)

RVS-3PHAS/125

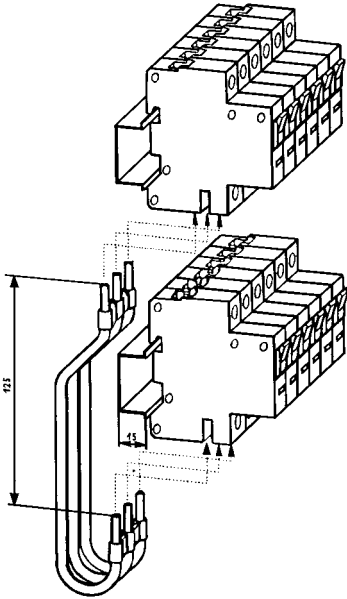

RVS-3PHAS/250

